

# **REMOTE CONTROLLER**

# **OWNER'S MANUAL**



## **IMPORTANT NOTE:**

Thank you for purchasing our air conditioner. Please read this manual carefully before operating your new air conditioning unit. Make sure to save this manual for future reference.

# Table of Contents

<b>Remote Controller Specifications .....</b>	<b>02</b>
<b>Handling the Remote Controller.....</b>	<b>03</b>
<b>Buttons and Functions .....</b>	<b>04</b>
<b>Remote Screen Indicators .....</b>	<b>06</b>
<b>How to Use Basic Functions .....</b>	<b>07</b>
<b>How to Use Advanced Functions.....</b>	<b>10</b>

# Remote Controller Specifications

<b>Model</b>	RG51A(2)/E, RG51B(2)/E , RG51Y7(2)/E
<b>Rated Voltage</b>	3.0V( Dry batteries R03/LR03x2)
<b>Signal Receiving Range</b>	8m
<b>Environment</b>	-5°C~60°C(23°F~140°F)

## Quick Start Guide

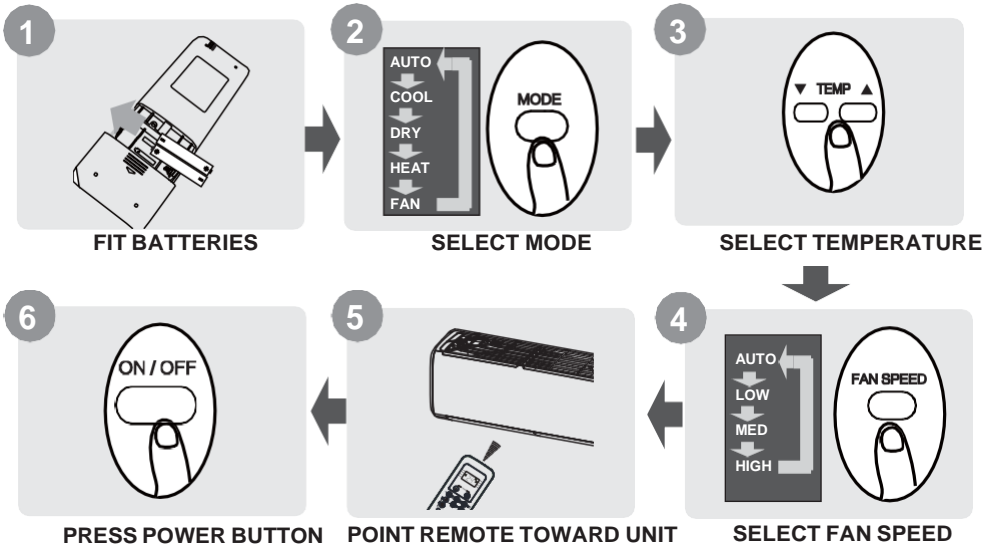

### NOT SURE WHAT A FUNCTION DOES?

Refer to the **How to Use Basic Functions** and **How to Use Advanced Functions** sections of this manual for a detailed description of how to use your air conditioner.

### SPECIAL NOTE

- Button designs on your unit may differ slightly from the example shown.
- If the indoor unit does not have a particular function, pressing that function's button on the remote control will have no effect.
- When there are wide differences between "Remote controller Manual" and "USER'S MANUAL" on function description, the description of "USER'S MANUAL" shall prevail.

# Handling the Remote Controller

## Inserting and Replacing Batteries

Your air conditioning unit may come with two batteries(some units). Put the batteries in the remote control before use.

1. Slide the back cover from the remote control downward, exposing the battery compartment.
2. Insert the batteries, paying attention to match up the (+) and (-) ends of the batteries with the symbols inside the battery compartment.
3. Slide the battery cover back into place.

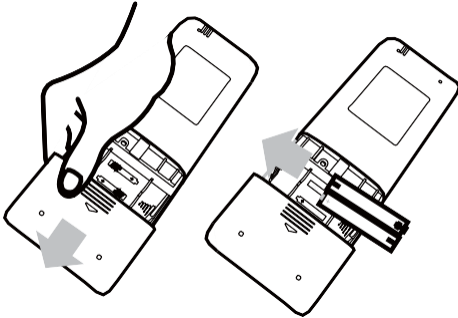

## ! BATTERY NOTES

For optimum product performance:

- Do not mix old and new batteries, or batteries of different types.
- Do not leave batteries in the remote control if you don't plan on using the device for more than 2 months.



## BATTERY DISPOSAL

Do not dispose of batteries as unsorted municipal waste. Refer to local laws for proper disposal of batteries.

## TIPS FOR USING REMOTE CONTROL

- The remote control must be used within 8 meters of the unit.
- The unit will beep when remote signal is received.
- Curtains, other materials and direct sunlight can interfere with the infrared signal receiver.
- Remove batteries if the remote will not be used more than 2 months.

## NOTES FOR USING REMOTE CONTROL

The device could comply with the local national regulations.

- In Canada, it should comply with CAN ICES-3(B)/NMB-3(B).
- In USA, this device complies with part 15 of the FCC Rules. Operation is subject to the following two conditions:
  - (1) This device may not cause harmful interference, and
  - (2) this device must accept any interference received, including interference that may cause undesired operation.

This equipment has been tested and found to comply with the limits for a Class B digital device, pursuant to part 15 of the FCC Rules. These limits are designed to provide reasonable protection against harmful interference in a residential installation. This equipment generates, uses and can radiate radio frequency energy and, if not installed and used in accordance with the instructions, may cause harmful interference to radio communications. However, there is no guarantee that interference will not occur in a particular installation. If this equipment does cause harmful interference to radio or television reception, which can be determined by turning the equipment off and on, the user is encouraged to try to correct the interference by one or more of the following measures:

- Reorient or relocate the receiving antenna.
- Increase the separation between the equipment and receiver.
- Connect the equipment into an outlet on a circuit different from that to which the receiver is connected.
- Consult the dealer or an experienced radio/TV technician for help.
- Changes or modifications not approved by the party responsible for compliance could void user's authority to operate the equipment.

# Buttons and Functions

Before you begin using your new air conditioner, make sure to familiarize yourself with its remote control. The following is a brief introduction to the remote control itself. For instructions on how to operate your air conditioner, refer to the **How to Use Basic Functions** section of this manual.

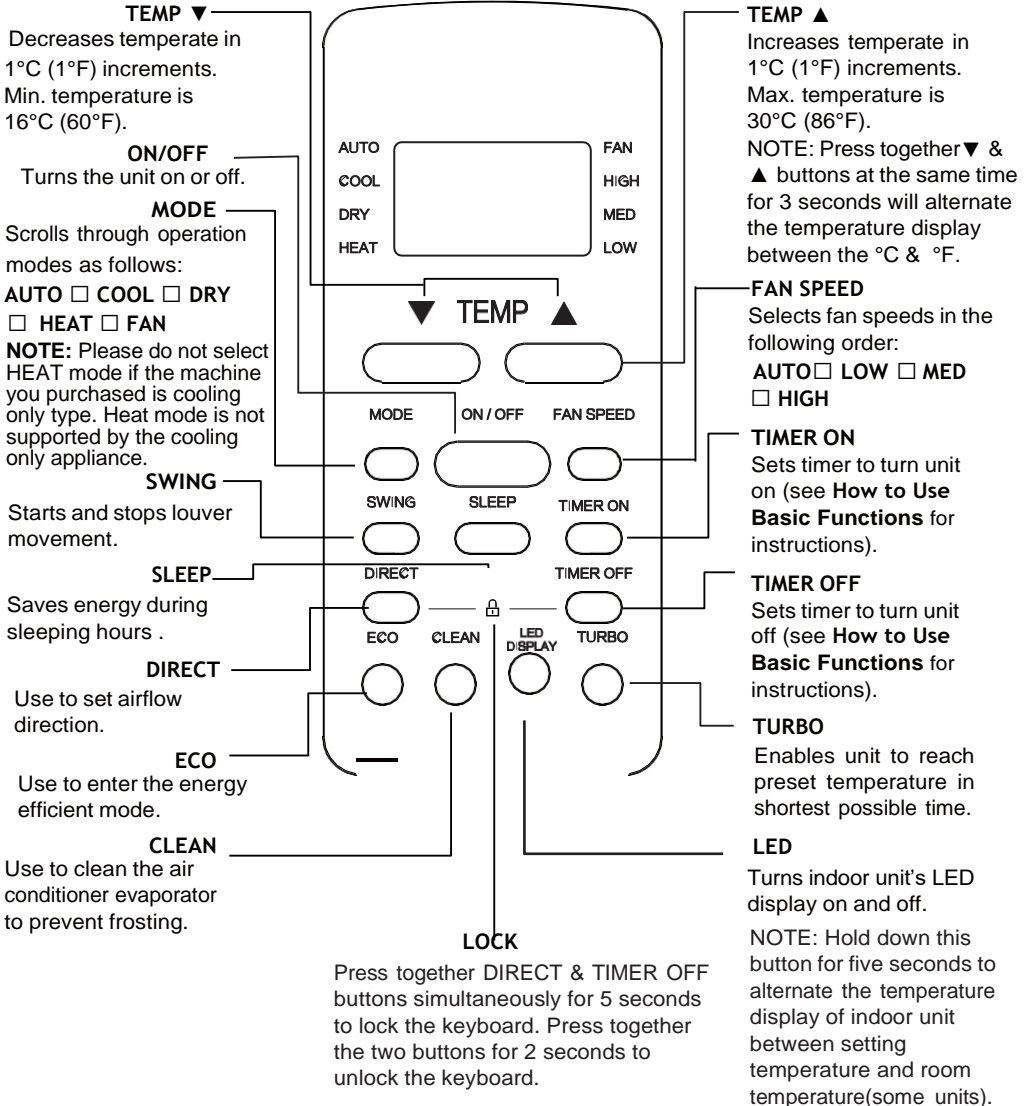

Model: RG51A(2)/E  
 RG51Y7(2)/E

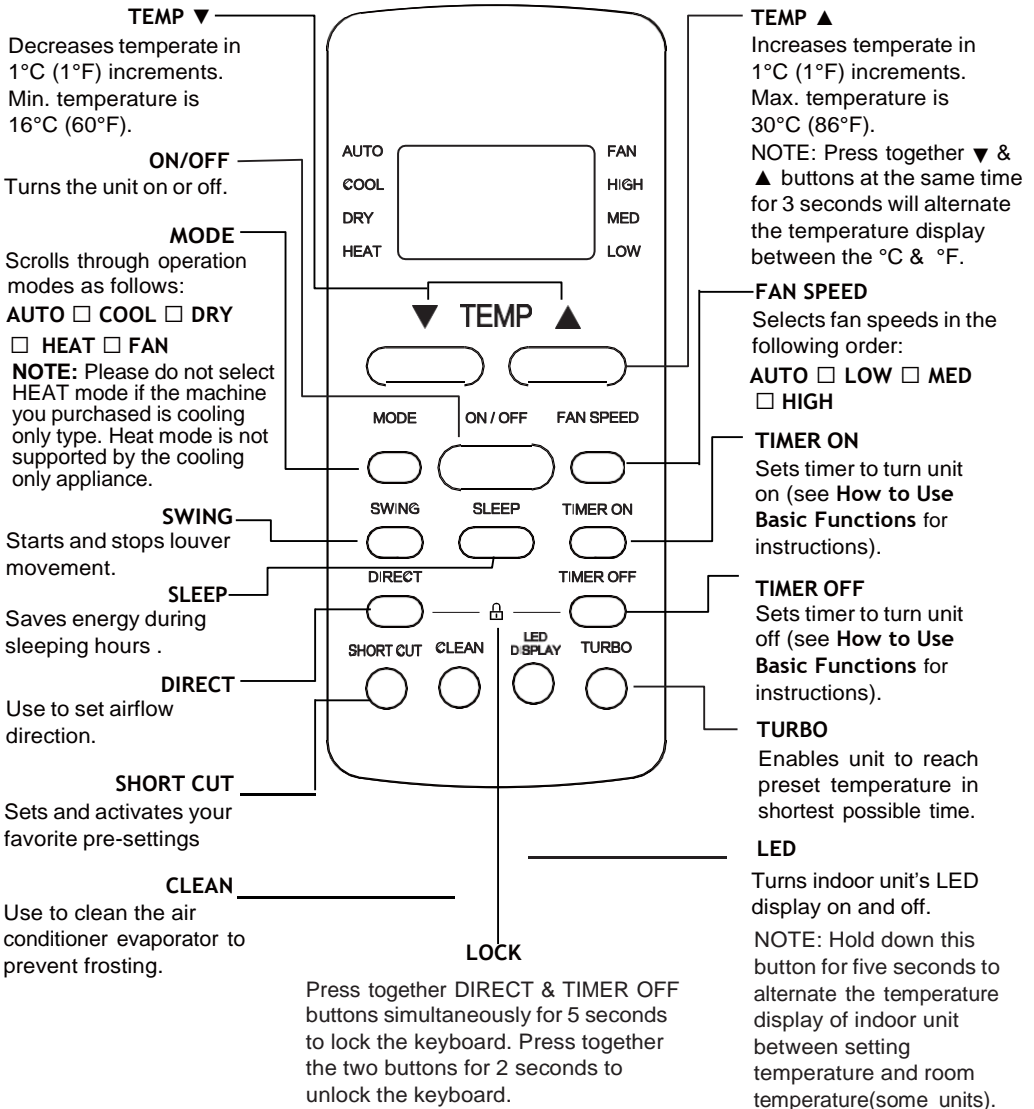

Model: RG51B(2)/E





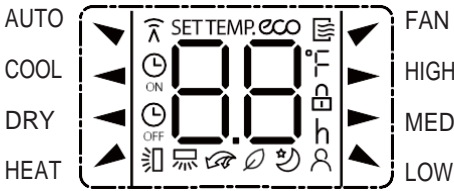







## Remote Screen Indicators

Information are displayed when the remote controller is power up.



### Mode display

AUTO ▼ COOL ◀ DRY ◀  
HEAT ▲ ▼ FAN

- 
-  Displayed when data transmitted.
  -  Displayed when remote controller is ON.
- 
-  Displayed when TIMER ON time is set
  -  Displayed when TIMER OFF time is set
  -  Shows set temperature or room temperature, or time under TIMER setting
  -  Displayed when ECO feature is activated
  -  Indicated all the current settings are locked
  -  Displayed when Follow Me feature is activated(some units)
  -  Displayed when SLEEP feature is activated
  -  Displayed when FRESH feature is activated(some units)
  -  Displayed when TRUBO feature is activated
  -  Horizontal louver auto swing display
  -  Vertical louver auto swing display(some units)

### Fan speed indication

- ▶ HIGH High speed
  - ▶ MED Medium speed
  - ▲ LOW Low speed
  - NO display Auto fan speed
- 

### Note:

All indicators shown in the figure are for the purpose of clear presentation. But during the actual operation, only the relative function signs are shown on the display window.

# How to Use Basic Functions

## Basic operation

**ATTENTION!** Before operation, please ensure the unit is plugged in and power is available.

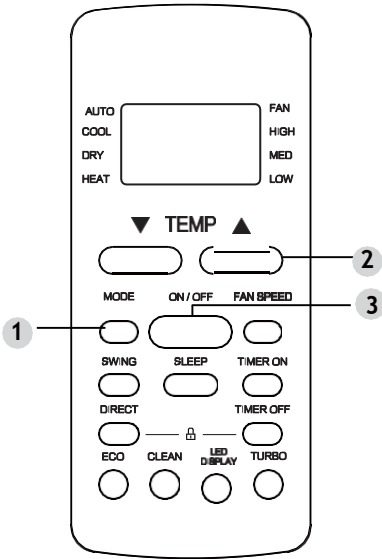

## COOL Mode

1. Press the **MODE** button to select **COOL** mode.
2. Set your desired temperature using the **TEMP ▲** or **TEMP ▼** button.
3. Press **FAN** button to select the fan speed: AUTO, LOW, MED or HIGH.
4. Press the **ON/OFF** button to start the unit.

## SETTING TEMPERATURE

The operating temperature range for units is 16-30°C (60-86°F). You can increase or decrease the set temperature in 1°C (1°F) increments.

## AUTO Mode

In AUTO mode, the unit will automatically select the COOL, FAN, or HEAT function based on the set temperature.

1. Press the **MODE** button to select **AUTO**.
2. Set your desired temperature using the **TEMP ▲** or **TEMP ▼** button.
3. Press the **ON/OFF** button to start the unit.

**NOTE:** FAN SPEED can't be set in AUTO mode.

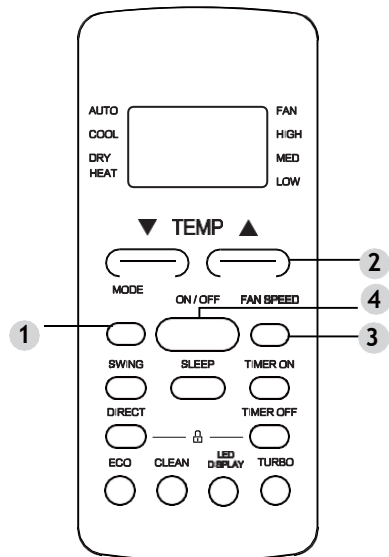



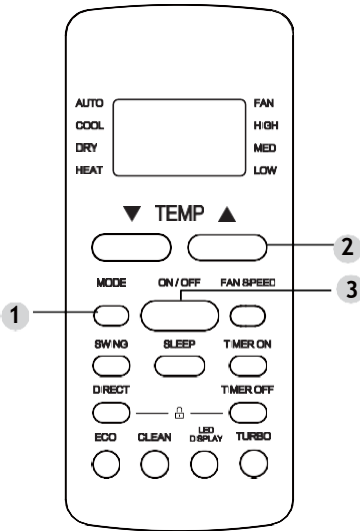

## DRY Mode (dehumidifying)

1. Press the **MODE** button to select **DRY**.
2. Set your desired temperature using the **TEMP ▲** or **TEMP ▼** button.
3. Press the **ON/OFF** button to start the unit.

**NOTE:** FAN SPEED cannot be changed in DRY mode.

## FAN Mode

1. Press the **MODE** button to select **FAN** mode.
2. Press **FAN** button to select the fan speed: AUTO, LOW, MED or HIGH.
3. Press the **ON/OFF** button to start the unit.

**NOTE:** You can't set temperature in FAN mode. As a result, your remote control's LCD screen will not display temperature.

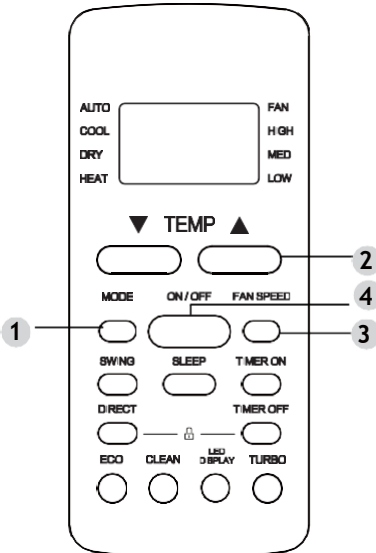
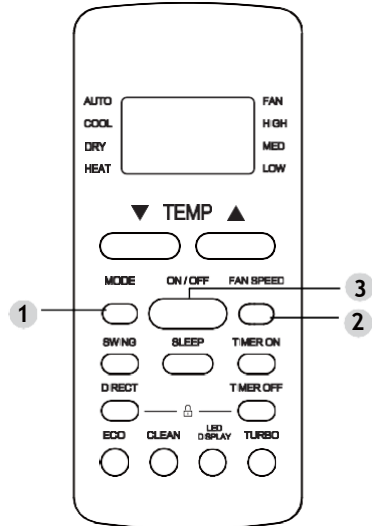

## HEAT Mode

1. Press the **MODE** button to select **HEAT** mode.
2. Set your desired temperature using the **TEMP ▲** or **TEMP ▼** button.
3. Press **FAN** button to select the fan speed: AUTO, LOW, MED or HIGH.
4. Press the **ON/OFF** button to start the unit.

**NOTE:** As outdoor temperature drops, the performance of your unit's HEAT function may be affected. In such instances, we recommend using this air conditioner in conjunction with other heating appliances.

## Setting the TIMER

**TIMER ON/OFF** - Set the amount of time after which the unit will automatically turn on/off.

### TIMER ON setting

Press **TIMER ON** button to initiate the ON time sequence.



Press **Temp. up or down** button for multiple times to set the desired time to turn on the unit.

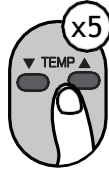

Point remote to unit and wait 1sec, the **TIMER ON** will be activated.



### TIMER OFF setting

Press **TIMER OFF** button to initiate the OFF time sequence.



Press **Temp. up or down** button for multiple times to set the desired time to turn off the unit.

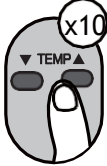

Point remote to unit and wait 1sec, the **TIMER OFF** will be activated.



#### NOTE:

- When setting the **TIMER ON** or **TIMER OFF**, the time will increase by 30 minutes increments with each press, up to 10 hours. After 10 hours and up to 24, it will increase in 1 hour increments. (For example, press 5 times to get 2.5h, and press 10 times to get 5h,) The timer will revert to 0.0 after 24.
- Cancel either function by setting its timer to 0.0h.

### TIMER ON & OFF setting(example)

Keep in mind that the time periods you set for both functions refer to hours after the current time.

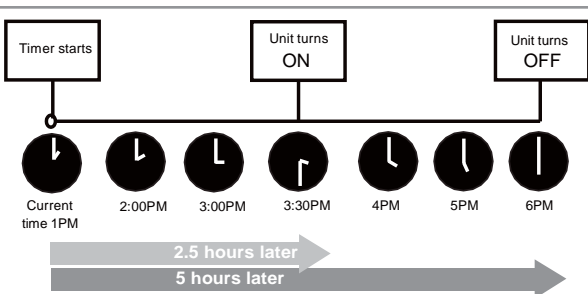
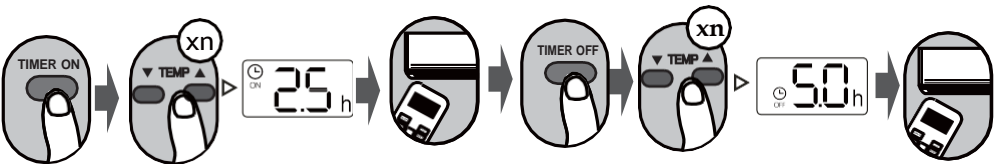

Example: If current timer is 1:00PM, to set the timer as above steps, the unit will turn on 2.5h later (3:30PM) and turn off at 6:00PM.

# How to Use Advanced Functions

## Swing function

Press Swing button

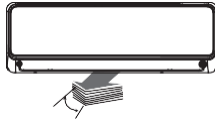

The horizontal louver will swing up and down automatically when pressing Swing button. Press again to make it stop.



Keep pressing this button more than 2 seconds, the vertical louver swing function is activated. (Model dependent)

## Airflow direction

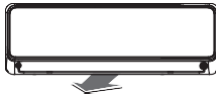

Each time you press the button, it will adjust the louver by 6°. Press the button until the direction you prefer is reached.

## LED DISPLAY

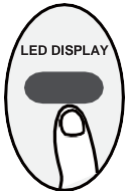

Press LED button

Press this button to turn on and turn off the display on the indoor unit.

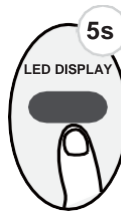

Press this button more than 5 seconds (some units)

Keep pressing this button more than 5 seconds, the indoor unit will display the actual room temperature. Press more than 5 seconds again will revert back to display the setting temperature.

## Active Clean Function

Press CLEAN button



The Active Clean Technology washes away dust, mold, and grease that may cause odors when it adheres to the heat exchanger by automatically freezing and then rapidly thawing the frost.

## ECO function



Press this button under COOL Mode to enter the energy efficient mode.  
(For model of RG51A(2)/E)

**Note:** This function is only available under COOL mode.

Under cooling mode, press this button, the remote controller will adjust the temperature automatically to 24°C/75°F, fan speed of Auto to save energy (only when the set temperature is less than 24°C/75°F). If the set temperature is above 24°C/75°F, press the ECO button, the fan speed will change to Auto, the set temperature will remain unchanged.

### NOTE:

Pressing the ECO button, or modifying the mode or adjusting the set temperature to less than 24°C/75°F will stop ECO operation.

Under ECO operation, the set temperature should be 24°C/75°F or above, it may result in insufficient cooling. If you feel uncomfortable, just press the ECO button again to stop it.

## SHORTCUT function



Used to restore the current settings or resume previous settings.  
(For model of RG51B(2)/E)

Push this button when remote controller is on, the system will automatically revert back to the previous settings including operating mode, setting temperature, fan speed level and sleep feature (if activated).

If pushing more than 2 seconds, the system will automatically restore the current operation settings including operating mode, setting temperature, fan speed level and sleep feature (if activated).

## SLEEP function



The SLEEP function is used to decrease energy use while you sleep (and don't need the same temperature settings to stay comfortable). This function can only be activated via remote control. The sleep function is not available in Fan or Dry mode. Please refer to the OWNER'S MANUAL for more details.

## Silence function



Keep pressing Fan button for more than 2 seconds to activate/disable Silence function(some units).

Due to low frequency operation of compressor, it may result in insufficient cooling and heating capacity. Press ON/OFF, Mode, Sleep, Turbo or Clean button while operating will cancel silence function.





The design and specifications are subject to change without prior notice for product improvement. Consult with the sales agency or manufacturer for details.

**CR249-RG51A-B(2)**