



USER'S MANUAL

Split Type Room Air Conditioner



IMPORTANT NOTE:

Read this manual carefully before installing or operating your new air conditioning unit. Make sure to save this manual for future reference.

CONTENTS

SAFETY PRECAUTIONS

Warning	4
Caution	5

OPERATING INSTRUCTIONS

Parts names	6
Special Functions	8
Air Filter Reminding Function(Optional)	8
Manual operation.....	11
Operating temperature.....	7
Airflow direction control	9

CARE AND MAINTENANCE

Care and maintenance	12-13
----------------------------	-------

TROUBLESHOOTING TIPS

Troubleshooting tips	14-15
----------------------------	-------

E-WASTE MANAGEMENT GUIDELINES

E-Waste Management Guidelines	18
-------------------------------------	----

ANNUAL MAINTENANCE CONTRACT

Annual Maintenance Contract	19
-----------------------------------	----

WARRANTY TERMS AND CONDITIONS

WARRANTY TERMS AND CONDITIONS	20-21
-------------------------------------	-------

WARRANTY CARD

Warranty card	22-23
---------------------	-------



**Caution: Risk of fire/
flammable materials**

WARNING: Servicing shall only be performed as recommended by the equipment manufacturer. Maintenance and repair requiring the assistance of other skilled personnel shall be carried out under the supervision of the person competent in the use of flammable refrigerants. For more details ,please refer to the “ Information on servicing” on “ INSTALLATION MANUAL ”.

CAUTION

- Contact an authorised service technician for repair or maintenance of this unit.
- Contact the authinstaller for installation of this unit.
- This appliance is not intended for use by persons(including children) with reduced physical, sensory or mental capabilities, or lack of experience and knowledge, unless they have been given supervision or instruction concerning use of the appliance by a person responsible for their safety.
- Young children should be supervised to ensure that they do not play with the air conditioner.
- If the power cord is to be replaced, replacement work shall be performed by authorised personnel only.
- Installation work must be performed in accordance with the national wiring standards by authorised personnel only.

Safety Precautions

Incorrect installation due to ignoring instructions can cause serious damage or injury. The seriousness of potential damage or injuries is classified as either a **WARNING** or **CAUTION**.



WARNING

This symbol indicates that ignoring instructions may cause death or serious injury.



CAUTION

This symbol indicates that ignoring instructions may cause moderate injury to your person, or damage to your appliance or other property.

WARNING

This appliance can be used by children aged from 8 years and above and persons with reduced physical, sensory or mental capabilities or lack of experience and knowledge if they have been given supervision or instruction concerning use of the appliance in a safe way and understand the hazards involved. Children shall not play with the appliance. Cleaning and user maintenance shall not be made by children without supervision.

INSTALLATION WARNINGS

- Ask an authorized dealer to install this air conditioner. Inappropriate installation may cause water leakage, electric shock, or fire.
- All repairs, maintenance and relocation of this unit must be performed by an authorized service technician. Inappropriate repairs can lead to serious injury or product failure.

WARNINGS FOR PRODUCT USE

- If an abnormal situation arises (like a burning smell), immediately turn off the unit and pull the power plug. Call your dealer for instructions to avoid electric shock, fire or injury.
- Do not insert fingers, rods or other objects into the air inlet or outlet. This may cause injury, since the fan may be rotating at high speeds.
- Do not use flammable sprays such as hair spray, lacquer or paint near the unit. This may cause fire or combustion.
- Do not operate the air conditioner in places near or around combustible gases. Emitted gas may collect around the unit and cause explosion.
- Do not operate the air conditioner in a wet room (e.g., bathroom or laundry room). This can cause electrical shock and cause the product to deteriorate.
- Do not expose your body directly to cool air for a prolonged period of time.

ELECTRICAL WARNINGS

- Only use the specified power cord. If the power cord is damaged, it must be replaced by the manufacturer or certified service agent.
- Keep power plug clean. Remove any dust or grime that accumulates on or around the plug. Dirty plugs can cause fire or electric shock.
- **Do not** pull power cord to unplug unit. Hold the plug firmly and pull it from the outlet. Pulling directly on the cord can damage it, which can lead to fire or electric shock.
- **Do not** use an extension cord, manually extend the power cord, or connect other appliances to the same outlet as the air conditioner. Poor electrical connections, poor insulation, and insufficient voltage can cause fire.





CLEANING AND MAINTENANCE WARNINGS

- Turn off the device and pull the plug before cleaning. Failure to do so can cause electrical shock.
- **Do not** clean the air conditioner with excessive amounts of water.
- **Do not** clean the air conditioner with combustible cleaning agents. Combustible cleaning agents can cause fire or deformation.

CAUTION

- If the air conditioner is used together with burners or other heating devices, thoroughly ventilate the room to avoid oxygen deficiency.
- Turn off the air conditioner and unplug the unit if you are not going to use it for a long time.
- Turn off and unplug the unit during storms.
- Make sure that water condensation can drain unhindered from the unit.
- **Do not** operate the air conditioner with wet hands. This may cause electric shock.
- **Do not** use device for any other purpose than its intended use.
- **Do not** climb onto or place objects on top of the outdoor unit.
- **Do not** allow the air conditioner to operate for long periods of time with doors or windows open, or if the humidity is very high.

Explanation of symbols displayed on the indoor unit or outdoor unit:

	WARNING	This symbol shows that this appliance used a flammable refrigerant. If the refrigerant is leaked and exposed to an external ignition source, there is a risk of fire.
	CAUTION	This symbol shows that the operation manual should be read carefully.
	CAUTION	This symbol shows that a service personnel should be handling this equipment with reference to the installation manual.
	CAUTION	
	CAUTION	This symbol shows that information is available such as the operating manual or installation manual.

OPERATING INSTRUCTIONS

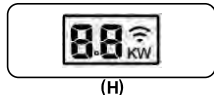
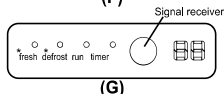
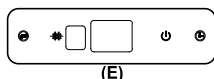
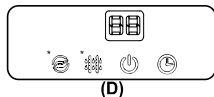
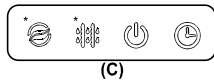
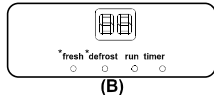
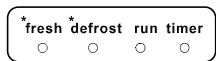
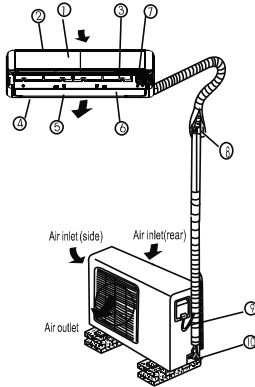

Indoor unit

1. Front panel
2. Air inlet
3. Air filter
4. Air outlet
5. Horizontal air flow grille
6. Vertical air flow louver (inside)
7. Display panel

NOTE: The actual shape of the indoor unit you purchased may be slight different on front panel and display window.

Outdoor unit

8. Connecting pipe
9. Connecting cable
10. Stop valve

NOTE:

All the pictures in this manual are for explanation purposes only. Your air conditioner may be slightly different. The actual shape shall prevail.

LED Display Window

FRESH indication lamp (optional)
Lights up when Clean Air feature is activated.

RUN indication lamp (optional)
This lamp illuminates when the air conditioner is in operation.

TIMER indication lamp (optional)
Lights up during Timer operation.

DEFROST indication lamp (optional)
(Enabled on cooling & heating models only):
Lights up when the air conditioner starts defrosting automatically or when the warm air control feature is activated in heating operation.

"KW" KW FUNCTION (optional)

Display the power consumption.

Wi-Fi FUNCTION (optional)

When wireless control feature is activated



Temperature indicator

- Displays the temperature settings when the air conditioner is operational.
- Displays the malfunction code.

Note:

1. * Marked function / feature is available in Selected Models only.
2. A guide on using the infrared remote is not included in this literature package.
3. "KW" function value is dependent on various factors and there may be slight variations in "KW" value as per actual power consumption/Energy meter used at the user end.
4. Various factors are power factor, Frequency. Indoor ambient temperature etc.
5. Kw value display as per mathematical logic of power consumption and might have tolerance of 0.05KW. E.g- when Power consumption is less than 0.05Kw then display will show 0.0 KW and if its below 0.15Kw and above 0.05KW then will display 0.1KW.

Achieving Optimal Performance

1. As per Bureau of Energy (Govt. of India) guidelines, Default set temperature has been kept as 24°C whenever the AC operated by remote, if user wants to change the set temperature, then user can set the desired temperature through remote key, as per his/her requirement.
2. Optimal performance for the cool, HEAT and DRY mode can be achieved in the following temperature ranges. When your air conditioner is used outside of these ranges, certain safety protection features will activate and cause the unit to perform less than optimally.

Inverter Split Type

COOL mode	
Room Temperature	17°C - 30°C (63°F - 86°F)
Outdoor Temperature	0°C - 50°C (32°F - 122°F)
	0°C - 55°C (32°F - 131°F) (For special tropical models)

FOR OUTDOOR UNITS WITH AUXILIARY ELECTRIC HEATER

When outside temperature is below 0°C (32°F), we strongly recommend keeping the unit plugged in at all time to ensure smooth ongoing performance.

Fixed-speed Type

COOL mode	
Room Temperature	17°-30°C (63°-86°F)
Outdoor Temperature	18°-48°C (64°-118°F)
	18°-54°C (64°-129°F) (For special tropical models)

To further optimize the performance of your unit, do the following:

- Keep doors and windows closed.
- Limit energy usage TIMER ON and TIMER OFF functions.
- Do not block air inlets or outlets.
- Regularly inspect and clean air filters.

For a detailed explanation of each function, refer to the Remote Control Manual.

Other Features

- **Auto-Restart**
If the unit loses power, it will automatically restart with the prior settings once power has been restored.
- **Anti-mildew (optional)**
When turning off the unit from COOL, AUTO (COOL), or DRY modes, the air conditioner will continue operate at very low power to dry up condensed water and prevent mildew growth.

To cancel the Anti-Midew function immediately, press Power on/off key 2 more times after pressing power on/off key one time
- **Wireless Control (optional)**
Wireless control allows you to control your air conditioner using your mobile phone and a Wireless connection.
For the USB device access, replacement, maintenance operations must be carried out by professional staff.
- **Louver Angle Memory (optional)**
When turning on your unit, the louver will automatically resume its former angle.
- **Refrigerant Leakage Detection (optional)**

The indoor unit will automatically display "EC"
The "timer" indicator light turns off and the "run" indicator light flashes 7 times when the unit detects refrigerant leakage.

- **Air Filter Reminder (optional)**

Air Filter Cleaning Reminder

After 240 hours of use, the "run" & "timer" indicator lamps on the indoor unit will flash simultaneously and the display window on the indoor unit will flash "CL" (if applicable). This is a reminder to clean your filter. After 15 seconds, the unit will revert to its previous display.

To reset the reminder, press the LED button on your remote control 4 times, or press the **MANUAL CONTROL** button 3 times. If you don't reset the reminder, the "CL", "run" & "timer" indicator lamps will flash again when you restart the unit.

- **Air Filter Replacement Reminder (optional)**

After 2,880 hours of use, the "run" & "timer" indicator lamps will flash simultaneously for 10 times, then remain on for five seconds, and the display window on the indoor unit will flash "nF" (if applicable). This is a reminder to replace your filter. After that, the unit will revert to its previous display.

To reset the reminder, press the LED button on your remote control 4 times, or press the **MANUAL CONTROL** button 3 times. If you don't reset the reminder, the "nF", "run" & "timer" indicator lamps will flash again when you restart the unit.

For a detailed explanation of your unit's advanced functionality (such as TURBO mode and its self-cleaning functions), refer to the Remote Control Manual

NOTE ON ILLUSTRATIONS

Illustrations in this manual are for explanatory purposes. The actual shape of your indoor unit may be slightly different. The actual shape shall prevail.

Setting Angle of Air Flow

Setting vertical angle of air flow (optional)

While the unit is on, use the **SWING/DIRECT** button to set the direction (vertical angle) of airflow.

1. Press the SWING/DIRECT button once to activate the louver. Each time you press the button, it will adjust the louver by 6°. Press the button until the direction you prefer is reached.
2. To make the louver swing up and down continuously, press and hold the **SWING/DIRECT** button for 3 seconds. Press it again to stop the automatic function.

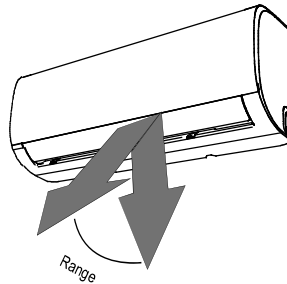

⚠ Caution: Do not keep louver at too vertical an angle for long periods of time. This can cause water condensation to drip on your furnishings.

Setting horizontal angle of air flow

The horizontal angle of the airflow must be set manually. Grip the deflector rod (See **Fig.B**) and manually adjust it to your preferred direction. For some units, the horizontal angle of the airflow can be set by remote control. Please refer to the Remote Control Manual.

NOTE ON LOUVER ANGLES

When using COOL or DRY mode, do not set louver at too vertical an angle for long periods of time. This can cause water to condense on the louver blade, which will drop on your floor or furnishings. (See **Fig.A**)

When using COOL or HEAT mode, setting the louver at too vertical an angle can reduce performance of the unit due to restricted airflow.

Do not move louver by hand. This will cause the louver to become out of sync. If this occurs, turn off the unit and unplug it for a few seconds, then restart the unit. This will reset the louver.

Fig. A

⚠ CAUTION
Do not put your fingers in or near the blower and suction side of the unit. The high-speed fan inside the unit may cause injury.

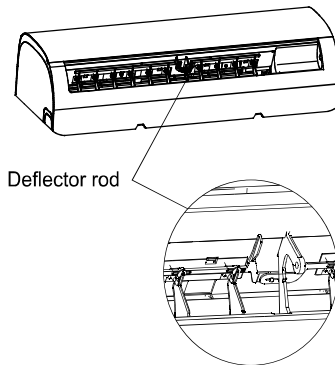

Fig. B

• Sleep Operation

The SLEEP function is used to decrease energy use while you sleep (and don't need the same temperature settings to stay comfortable). This function can only be activated via remote control

Press the SLEEP button when you are ready to go to sleep. When in COOL mode, the unit will increase the temperature by 1°C (2°F) after 1 hour, and will increase an additional 1°C (2°F) after another hour. When in HEAT mode, the unit will decrease the temperature by 1°C (2°F) after 1 hour, and will decrease an additional 1°C (2°F) after another hour.

Note: The SLEEP function is not available in FAN or DRY mode.

For some units, the sleep feature will stop after 8 hours and the system will keep running with final situation.

For some units, the unit will turn off after 7 hours.

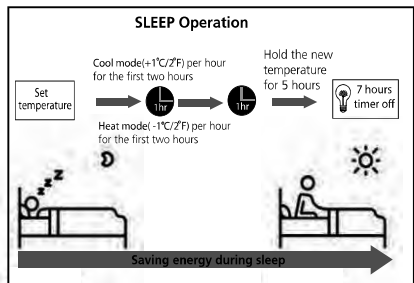
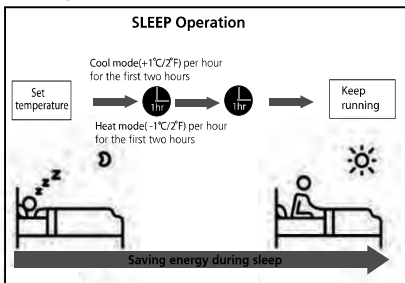

Manual Operation (Without Remote)

2

How to operate your unit without the remote control

In the event that your remote control fails to work, your unit can be operated manually with the **MANUAL CONTROL** button located on the indoor unit. Note that manual operation is not a long-term solution, and that operating the unit with your remote control is strongly recommended.

BEFORE MANUAL OPERATION

Unit must be turned off before manual operation.

To operate your unit manually:

1. Open the front panel of the indoor unit.
2. Locate the **MANUAL CONTROL** button on the right-hand side of the unit.
3. Press the **MANUAL CONTROL** button one time to activate FORCED AUTO mode.
4. Press the **MANUAL CONTROL** button again to activate FORCED COOLING mode.
5. Press the **MANUAL CONTROL** button a third time to turn the unit off.
6. Close the front panel.

! CAUTION

The manual button is intended for testing. Please do not use this function unless the remote is lost and it is absolutely necessary. To resume regular operation, use the remote control to activate the unit.

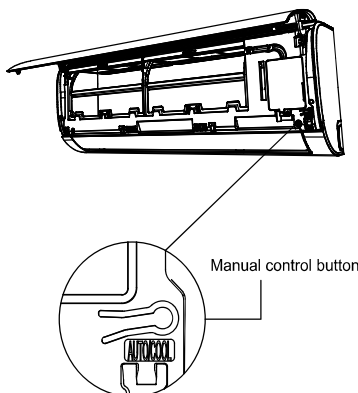

Manual Operation
(Without Remote)

Care and Maintenance

3

Cleaning Your Indoor Unit

BEFORE CLEANING OR MAINTENANCE

ALWAYS TURN OFF YOUR AIR CONDITIONER SYSTEM AND DISCONNECT ITS POWER SUPPLY BEFORE CLEANING OR MAINTENANCE.

CAUTION

Only use a soft, dry cloth to wipe the unit clean. If the unit is especially dirty, you can use a cloth soaked in warm water to wipe it clean.

- Do not use chemicals or chemically treated cloths to clean the unit
- Do not use benzene, paint, thinner, polishing powder or other solvents to clean the unit. They can cause the plastic surface to crack or deform.
- Do not use water hotter than 40°C (104°F) to clean the front panel. This can cause the panel to deform or become discolored.

Cleaning Your Air Filter

A clogged air conditioner can reduce the cooling efficiency of your unit, and can also be bad for your health. Make sure to clean the filter once every two weeks.

1. Lift the front panel of the indoor unit.
2. First press the tab on the end of filter to loosen the buckle, lift it up, then pull it towards yourself.
3. Now pull the filter out.
4. If your filter has a small air freshening filter, unclip it from the larger filter. Clean this air freshening filter with a hand-held vacuum.
5. Clean the large air filter with warm, soapy water. Be sure to use a mild detergent.

6. Rinse the filter with fresh water, then shake off excess water
7. Dry it in a cool, dry place, and refrain from exposing it to direct sunlight.
8. When dry, re-clip the air freshening filter to the larger filter, then slide it back into the indoor unit.
9. Close the front panel of the indoor unit.

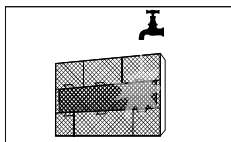
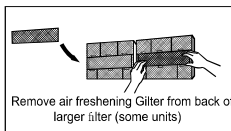
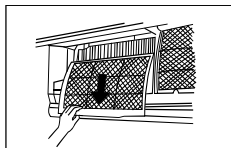
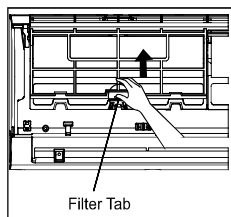

CAUTION

Do not touch air freshening (Plasma) filter for at least 10 minutes after turning off the unit.

! CAUTION

- Before changing the filter or cleaning, turn off the unit and disconnect its power supply.
- When removing filter, do not touch metal parts in the unit. The sharp metal edges can cut you.
- Do not use water to clean the inside of the indoor unit. This can destroy insulation and cause electrical shock.
- Do not expose filter to direct sunlight when drying. This can shrink the filter.

Air Filter Reminders (Optional)

Air Filter Cleaning Reminder

After 240 hours of use, the display window on the indoor unit will flash "CL." This is a reminder to clean your filter. After 15 seconds, the unit will revert to its previous display

To reset the reminder, press the **LED** button on your remote control 4 times, or press the **MANUAL CONTROL** button 3 times. If you don't reset the reminder, the "CL" indicator will flash again when you restart the unit.

Air Filter Replacement Reminder

After 2,880 hours of use, the display window on the indoor unit will flash "nF." This is a reminder to replace your filter. After 15 seconds, the unit will revert to its previous display

To reset the reminder, press the **LED** button on your remote control 4 times, or press the **MANUAL CONTROL** button 3 times. If you don't reset the reminder, the "nF" indicator will flash again when you restart the unit.

! CAUTION

- Any maintenance and cleaning of outdoor unit should be performed by an authorized dealer or licensed service provider.
- Any unit repairs should be performed by authorized dealer or licensed service provider.

Maintenance – Long Periods of Non-Use

If you plan not to use your air conditioner for an extended period of time, do the following:

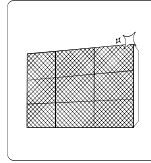

Clean all filters



Turn on FAN function until unit dries out completely



Turn off the unit and disconnect the power

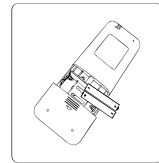

Remove batteries from remote control

Maintenance – Pre-Season Inspection

After long periods of non-use, or before periods of frequent use, do the following:

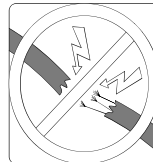

Check for damaged wires

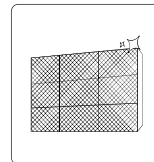

Clean all filters



Check for leaks

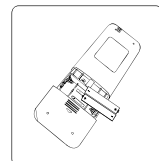

Replace batteries

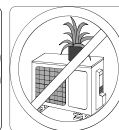

Make sure nothing is blocking all air inlets and outlets

Troubleshooting

4

! SAFETY PRECAUTIONS

If **ANY** of the following conditions occurs, turn off unit immediately!

- . The power cord is damaged or abnormally worn.
- . You smell a burring odor.
- . A unit emits loud or abnormal sounds.
- . A power fuse blows or the circuit breaker frequently trips.
- . Water or other objects fall into or out of the unit.

DO NOT ATTEMPT TO FIX THESE YOURSELF ! CONTACT SERVICE PROVIDER IMMEDIATELY!

Common Issue

The following problems are not malfunctions and in most situations will not require repairs.

Issue	Possible Causes
Unit does not turn on when pressing ON/OFF button	The Unit has a 3-minute protection feature that prevents the unit from overloading. The unit cannot be restarted within three minutes of being turned off.
The unit changes from COOL/HEAT mode to FAN mode	The unit may change its setting to prevent frost from forming on the unit. Once the temperature increases, the unit will start operating in the previously selected mode again.
	The set temperature has been reached, at which point the unit turns off the compressor. The unit will continue operating when the temperature fluctuates again.
The indoor unit emits white mist	In humid regions, a large temperature difference between the room's air and the conditioned air can cause white mist.
Both the indoor and outdoor units emit white mist	When the unit restarts in HEAT mode after defrosting, white mist may be emitted due to moisture generated from the defrosting process.

Issue	Possible Causes
The indoor unit makes noises	A rushing air sound may occur when the louver resets its position.
	A squeaking sound may occur after running the unit in HEAT mode due to expansion and contraction of the unit's plastic parts.
Both the indoor unit and outdoor unit make noises	Low hissing sound during operation: This is normal and is caused by refrigerant gas flowing through both indoor and outdoor units.
	Low hissing sound when the system starts, has just stopped running, or is defrosting: This noise is normal and is caused by the refrigerant gas stopping or changing direction.
	Squeaking sound: Normal expansion and contraction of plastic and metal parts caused by temperature changes during operation can cause squeaking noises.
The outdoor unit makes noises	The unit will make different sounds based on its current operating mode.
Dust is emitted from either the indoor or outdoor unit	The unit may accumulate dust during extended periods of non-use, which will be emitted when the unit is turned on. This can be mitigated by covering the unit during long periods of inactivity.
The unit emits a bad odor	The unit may absorb odors from the environment (such as furniture, cooking, cigarettes, etc.) which will be emitted during operations.
	The unit's filters have become moldy and should be cleaned.
The fan of the outdoor unit does not operate	During operation, the fan speed is controlled to optimize product operation.
Operation is erratic, unpredictable, or unit is unresponsive	<p>Interference from cell phone towers and remote boosters may cause the unit to malfunction.</p> <p>In this case, try the following:</p> <ul style="list-style-type: none"> . Disconnect the power, the reconnect. . Press ON/OFF button on remote control to restart operation.

NOTE: If problem persists, contact a local dealer or your nearest customer service center. Provide them with a detailed description of the unit malfunction as well as your model number.

Troubleshooting

When troubles occur, please check the following points before contacting a repair company.

Problem	Possible Causes	Solution
Poor Cooling Performance	Temperature setting may be higher than ambient room temperature	Lower the temperature setting
	The heat exchanger on the indoor or outdoor unit is dirty	Clean the affected heat exchanger
	The air filter is dirty	Remove the filter and clean it according to instructions
	The air inlet or outlet of either unit is blocked	Turn the unit off, remove the obstruction and turn it back on
	Doors and windows are open	Make sure that all doors and windows are closed while operating the unit
	Excessive heat is generated by sunlight	Close windows and curtains during periods of high heat or bright sunshine
	Too many sources of heat in the room (people, computers, electronics, etc.)	Reduce amount of heat sources
	Low refrigerant due to leak or long-term use	Check for leaks, re-seal if necessary and top off refrigerant
SILENCE function is activated(optional function)	SILENCE function can lower product performance by reducing operating frequency. Turn off SILENCE function.	

Problem	Possible Causes	Solution
The unit is not working	Power failure	Wait for the power to be restored
	The power is turned off	Turn on the power
	The fuse is burned out	Replace the fuse
	Remote control batteries are dead	Replace batteries
	The Unit's 3-minute protection has been activated	Wait three minutes after restarting the unit
	Timer is activated	Turn timer off
The unit starts and stops frequently	There's too much or too little refrigerant in the system	Check for leaks and recharge the system with refrigerant.
	Incompressible gas or moisture has entered the system.	Evacuate and recharge the system with refrigerant
	The compressor is broken	Replace the compressor
	The voltage is too high or too low	Install a manostat to regulate the voltage
Poor heating performance	The outdoor temperature is extremely low	Use auxiliary heating device
	Cold air is entering through doors and windows	Make sure that all doors and windows are closed during use
	Low refrigerant due to leak or long-term use	Check for leaks, re-seal if necessary and top off refrigerant
Indicator lamps continue flashing	The unit may stop operation or continue to run safely. If the indicator lamps continue to flash or error codes appear wait for about 10 minutes. The problem may resolve itself.	
Error code appears in the window display of indoor unit: • E0, E1, E2... • P1, P2, P3... • F1, F2, F3...	If not, disconnect the power, then connect it again. Turn the unit on. If the problem persists, disconnect the power and contact your nearest customer service center	

NOTE: If your problem persists after performing the checks and diagnostics above, turn off your unit immediately and contact an authorized service center

E-WASTE MANAGEMENT GUIDELINES



E-WASTE MANAGEMENT GUIDELINES (PERTAINING TO THE E-WASTE RULES)

PROPER HANDLING AND/OR RECYCLING OF THE AIR CONDITIONER

Under the E-Waste (Management & Handling) Rules, 2011 (hereafter referred to as the "E-Waste Rules"), it is incumbent for all consumers, including the purchaser of this air-conditioner, to properly recycle and dispose of all electrical and electronic equipment through authorized recyclers.

E-Waste has been defined as "waste electrical and electronic equipment, whole or in part or rejects from their manufacturing and repair process, which are intended to be discarded".

E-Waste contains various hazardous materials like lead, mercury, cadmium, hexavalent chromium, polybrominated biphenyls and polybrominateddiphenyls ethers. Hence, improper handling and disposal of e-waste releases these hazardous material in the environment causing pollution, contamination of soil and water and various health hazards. Though the product purchased by you is ROHS compliant and does not contain any hazardous material above the prescribed limit under the E-Waste Rules, it is imperative that the product should be handled with utmost caution and as per the guidelines mentioned in this manual including the following Do's and Don'ts –

Do's	Don'ts
Hand over the E-Waste to Authorised Recycler.	Never sell the e-waste to any unauthorized agencies, scrap dealer/kabadiwalahs.
E-Waste should be segregated from household and other wastes.	Never throw E-Waste in bins as part of household waste.
Keep the product in isolated area, after it becomes non-functional/un-repairable so as to prevent its accidental breakage.	Never keep E-Waste in open and exposed area, accessible by all.
The product should be opened only by authorised service personnel.	The product should not be opened by the user himself/herself. Dismantling of e-waste by the user can be dangerous

The following marking/symbol on the product or carton indicates that the product and its accessories/parts (e.g. remote controller, batteries, spare parts etc.) should not be disposed of with other household waste at the end of their working life. Please separate these items from other types of waste and recycle them responsibly for conservation of the environment and collective well-being.



E-WASTE RECYCLING PROGRAM

We have tied up with government approved e-waste recycler for facilitating the collection of e-waste from our channel partners and customers for recycling. You are simply required to call our toll free number 18001033333 and register your request for collection of e-waste. Once your request is received, the representatives of the authorized recycler would collect the e-waste from your house/premises after paying the value of the same to you. For more details and information on our E-Waste Recycling Program kindly visit our website www.carriermidea.com.

ANNUAL MAINTENANCE CONTRACT

ANNUAL MAINTENANCE CONTRACT

Our air conditioners contain various components and inputs that are technical in nature and it is important that any repair or replacement of any of the components of the air conditioners is done only by the personnel authorized by Carrier.

We at Carrier Midea India Pvt. Ltd. believe in providing our valued customers the best in engineered technology & quality performance for extreme Indian conditions. Striving to keep our commitments and to ensure best product performance, We offer to you exciting “ Happy Homes Annual Maintenance plans” to cover the service support for your products.

We recommend that you avail Happy Homes annual maintenance services from us in order to optimize the performance and the life span of your conditioners and also to ensure their safe and proper handling.

You can contact to us on our call center number 18001033333 to register your request for Annual Maintenance services or you can write to us on carriercare@carriermidea.com

WARRANTY TERMS AND CONDITIONS

CARRIER MIDEA INDIA PRIVATE LIMITED (hereinafter referred to as the "Company"), hereby warrants to the original domestic purchaser (here in after called the "Purchaser") of the air-conditioning unit (as detailed within the Warranty Registration Card and here in after referred to as the "said unit") that the said unit is free from defects in materials and workmanship under normal use and service and under specified voltage conditions, and that during a period of twelve (12) months commencing from the date of invoice, as provided in the Warranty Card, the Company undertakes to repair or to replace any part or parts of the said unit (including the compressor, condenser and evaporator) free of charge which proves to be defective in materials or workmanship at its sole discretion.

ADDITIONAL WARRANTY ON COMPRESSOR

The additional warranty on Compressor will be continuous even after the expiry off one year period from date of purchase (4 year* for Normal Compressor & 9 year** for Inverter Compressor (selected Models) shall be applicable after the expiry of one year period from the date of purchase). This additional warranty covers compressor only. During the additional warranty period, it does not cover any parts such as condenser coil, evaporator coil, capillary, suction line electronics parts, etc., the Company shall continue to warranty the compressor to be free from defects in material and workmanship under normal use and service and under specified voltage conditions. The Company shall repair or replace without cost to the original purchaser, any part or portion of the compressor, which shall be returned to us, transportation charges prepaid and which on inspection shall be shown to be thus defective. Expendable items like refrigerant gas, overload, oil, dryer, strainer and others are excluded from this warranty and are on chargeable basis. This warranty is subject to use of air-conditioner with input voltage of 230 V +/-10%. We recommend use of approved make of voltage stabilizer with output voltage of 230 V +/-10%. The terms and conditions as set out below shall form the basis of this warranty:

***For Normal Compressor (4 Year Warranty)**

**** For Inverter Compressor (9 Year Warranty)**

1. The warranty shall be valid and that the Purchaser can have the benefit of this warranty, if and only if the Purchaser has duly intimated the fault to the Company or its authorized dealer if the and that the unit is in the possession of and is used by the Purchaser.
2. At the time of repair/service, the Purchaser is mandatorily required to show the original invoice to the authorized service personnel of the Company. If the purchaser fails to do so, then all repair work and service shall be carried out on a chargeable basis;
3. This warranty shall be valid only for the Warranty period irrespective of whether the said Unit has been in use or not for any reason whatsoever.
4. The Warranty will shall be valid only for the said period of twelve months as specified above, irrespective of whether the said unit has been in use or not for any reason whatsoever, or the unit is moved from one location to another. The warranty period specified above shall include time taken for repairs, replacements, testing of unit, technical breakdowns, transit time etc. This warranty shall automatically expire by efflux of time on completion of the period indicated herein above and no notice of such expiry will be given by the Company.
5. This warranty shall stand automatically terminated in the event of the said unit being serviced, repaired, installed, de-installed, re-installed or otherwise attended to by and person or organization or agency or by the said purchaser himself (by whatever name called), other than the authorized representative / Dealer of the the Company.
6. Parts of the units replaced or repaired under the terms of this warranty are warranted only for the remaining period of the original warranty period.

WARRANTY TERMS AND CONDITIONS

7. For attending any service call under this warranty beyond the Municipal limits of the locality in which the authorized representative/dealer is situated (outstation locations), all to and fro traveling and other incidental expenses as prevailing from time to time incurred in connection with the visit of the service personnel, technicians etc., shall be borne by the Purchaser and shall be payable in advance.

Additionally, all expenses incurred by the authorized representative/dealer in collecting the unit or any part thereof from such outstation locations and its return to the original location shall be borne exclusively by the Purchaser.
8. Any loss of refrigerant caused due to sabotage, improper handling or treatment, carelessness, accident, fire, flood, earthquake or any act of God, or any corrosive action on the original refrigerant pipes, fittings, valves etc. for whatever reason, shall not be covered under this warranty.
9. In the event of any change in the location of the unit, during the warranty period, this warranty shall become null and void unless the fact of the proposed change is communicated in writing to the authorized dealer at least seven (7) days prior to the said change. On receipt of such information, the authorized dealer or any of its counterparts shall arrange for de-installation of the said unit on a chargeable basis. However, it is expressly stated that in the event of any damage occurring to the unit or to any of its parts during the course of its transit by the Purchaser, repair or replacement of the said unit or any part thereof so damaged shall not be covered by this warranty.
10. While the Authorized Dealers/Company will make every effort to carry out repairs/replacement of parts under this warranty as soon as the complaint is received, it is expressly made clear that the Authorized Dealer/Company shall not be liable to do so within any specified period of time.
11. It shall be absolute discretion of the Company to (a) effect the repairs or replacement of parts whether at the site of installation or at any service center; and (b) have the job attended to either by the Company's service personnel or of its authorized dealers.
12. This warranty is in the nature of and for the purposes as set forth herein above and in particular, the Company shall not in any event be liable for any direct, indirect, incidental or consequential loss or damages to either the said purchaser and/or his property or any other third party in course of attending to any complaint.
13. Limitation of Warranty: Company shall not be responsible for providing any warranty under the following situations:
 - i. any damage caused by accident, mishandling, tampering with installation, or negligent in following instructions of the user manual issued by the Company.
 - ii. any damage caused by power surges and dips, improper electrical circuit outside the unit or by any defective electrical supply.
 - iii. at any time, during the currency of the warranty period, if any part of the unit is tampered with, altered, repaired or serviced by any unauthorized person, not being the authorized representative of the Company or its authorized dealers.
 - iv. If the said unit or any parts thereof is damaged by insects, rats, birds, squirrels, pests or any other external factors like fire, flood, earthquake, lightning and/or any other act of God/natural calamities;

WARRANTY TERMS AND CONDITIONS

- v. Any defect due to substitution of original components with non-genuine components;
 - vi. Damage to the said Unit due to use of any ancillary equipment which is not authenticated or recommended by the Company;
 - vii. The serial number on the unit or any part thereof is damaged, defaced, altered, obliterated, or tampered with or removed for any reason whatsoever.
 - viii. The unit is unauthorizedly removed from its original place or installation or reinstallation.
 - ix. Condenser and Evaporator is found defective if the air conditioner is installed near the muddy sewages because toxic gases are harmful for the AC.
 - x. Damage to the product due to operation in an abnormally corrosive alkaline / acidic atmosphere.
14. None of the employees and/or Authorized dealers of the Company have the authority whatsoever to vary the terms and conditions of this warranty.
15. This warranty shall be deemed to have been issued at Gurgaon in the State of Haryana, and Courts at Gurgaon shall have exclusive jurisdiction on matters covered by or following from this warranty, and the purchaser alone shall have cause of action arising out of the transaction.

WARRANTY CARD

WARRANTY

Carrier Midea India Private Limited

Customer Copy

Model :

NAME OF CUSTOMER :

ADDRESS :

Sr. No. of the Unit :

Sr. No. of the Compressor :

Invoice No. :

Date of Purchase :

Name & Address of the Dealer :



Signature of the Dealer with seal :

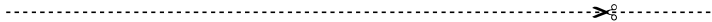

WARRANTY

Carrier Midea India Private Limited

Carrier Copy

Model :

NAME OF CUSTOMER :

ADDRESS :

Sr. No. of the Unit :

Sr. No. of the Compressor :

Invoice No. :

Date of Purchase :

Name & Address of the Dealer :



Signature of the Dealer with seal :

WARRANTY CARD

PRODUCT WARRANTY CERTIFICATE

CARRIER MIDEA INDIA PRIVATE LIMITED (company) warrants this Room air conditioner to the original purchaser to be free from defects in material and workmanship under normal use and service and under specified voltage conditions and we shall, within one year from the date hereof, repair or replace any defect without cost to the original purchaser, a part or portion thereof which shall be returned to us, transportation charges prepaid, and which on inspection by the Company shall be shown to be thus defective. Plastic parts beyond the date of delivery, fuses, air filters, refrigerants, all and other expandable items are excluded from this warranty.

ADDITIONAL COMPRESSOR WARRANTY

For Additional warranty on Compressor (4 year for Normal Compressor & 9 year for Inverter Compressor), following the expiration of the entire unit warranty, the Company shall continue to warrant the compressor only to be free from defects in material and workmanship under normal use and service and under specified voltage conditions. The Company shall repair or replace without cost to the original purchaser compressor, any part or portion of the compressor, which shall be returned to the Company, transportation charges prepaid and which on inspection shall be shown to be thus defective. Expendable items like refrigerant gas (which is required to be filled in again mandatorily at the time of repairing or replacing the compressor), overload, oil, dryer, strainer and others are excluded from this warranty and are on chargeable basis.

These warranties, however, shall not apply if the room air-conditioner has been installed in a manner affecting the efficiency or performance, or if the room air-conditioner has been tampered with, altered or in any way, repaired, serviced or worked on by anybody other than the Company's own technicians/staff or its authorized representative. This warranty shall also NOT apply to the compressor which has the serial numbers altered, defected or removed. The company shall not be liable for any injury, loss, or damage (direct, indirect, or consequential) of whatsoever arising out of the use or inability to use the product.



-----><-----

PRODUCT WARRANTY CERTIFICATE

CARRIER MIDEA INDIA PRIVATE LIMITED (company) warrants this Room air conditioner to the original purchaser to be free from defects in material and workmanship under normal use and service and under specified voltage conditions and we shall, within one year from the date hereof, repair or replace any defect without cost to the original purchaser, a part or portion thereof which shall be returned to us, transportation charges prepaid, and which on inspection by the Company shall be shown to be thus defective. Plastic parts beyond the date of delivery, fuses, air filters, refrigerants, all and other expandable items are excluded from this warranty.

ADDITIONAL COMPRESSOR WARRANTY

For Additional warranty on Compressor (4 year for Normal Compressor & 9 year for Inverter Compressor), following the expiration of the entire unit warranty, the Company shall continue to warrant the compressor only to be free from defects in material and workmanship under normal use and service and under specified voltage conditions. The Company shall repair or replace without cost to the original purchaser compressor, any part or portion of the compressor, which shall be returned to the Company, transportation charges prepaid and which on inspection shall be shown to be thus defective. Expendable items like refrigerant gas (which is required to be filled in again mandatorily at the time of repairing or replacing the compressor), overload, oil, dryer, strainer and others are excluded from this warranty and are on chargeable basis.

These warranties, however, shall not apply if the room air-conditioner has been installed in a manner affecting the efficiency or performance, or if the room air-conditioner has been tampered with, altered or in any way, repaired, serviced or worked on by anybody other than the Company's own technicians/staff or its authorized representative. This warranty shall also NOT apply to the compressor which has the serial numbers altered, defected or removed. The company shall not be liable for any injury, loss, or damage (direct, indirect, or consequential) of whatsoever arising out of the use or inability to use the product.





For more details please contact Carrier Midea India Pvt. Ltd.:

REGISTERED OFFICE : 1st Floor, Pearl Global Tower, Plot No. 51, Institutional Area, Sector 32, Gurgaon - 122001, Haryana.

SALES OFFICES: **Gurgaon:** 0124-6144300, **Ghaziabad:** 0120-4183260, **Chandigarh:** 0172-5007548-50, **Jaipur:** 0141-4109080
Mumbai: 022-26528989, 42188800, **Pune:** 020-41051000, **Goa:** 0832-2447028, **Ahmedabad:** 079-40267777, **Kolkata:** 033-40201300, **Chennai:**
044-42228888, **Bangalore:** 080-43442000, **Patna:** 0612-2323517, **Hyderabad:** 040-45462888, **Cochin:** 0484-4029001, **Lucknow:** 0522-4158710,
Indore: 0731-4294700, **Pondicherry:** 0413-2226676, **Coimbatore:** 0422-4385400, **Guwahati:** 0361-2666077, **Bhubaneswar:** 0674-2585893,
Nagpur: 0712-6453790, **Ranchi:** 0651-6452488, 2330095, **Raipur:** 0771-4013245.

Visit us at : www.carriermideaindia.com

The design and specifications are subject to change without prior notice for product improvement. Consult with the sales agency or manufacturer for details.

ACI3PR26801