



USER'S MANUAL

Split Type Room Air Conditioner



IMPORTANT NOTE:

Read this manual carefully before installing or operating your new air conditioning unit. Make sure to save this manual for future reference.

Contents

Split Type Room Air Conditioner-R32

❖ Use and Care Manual

Under Preparation Before Use -----	4
Safety Precautions -----	5
Identification of Parts-----	6
Display Introduction -----	7
Remote Controller -----	8-9
Operation Instructions -----	10-15
Safety Instructions -----	16-18
Maintenance -----	19
Protection -----	20
Troubleshooting -----	21
Troubleshooting Chart -----	22
Installation Instructions -----	23-30
E-waste Management Guidelines -----	31
Annual Maintenance Contract-----	32
Warranty Terms and Conditions-----	33-35
Warranty Card-----	36-37

Under Preparation before use

Before using the air conditioner, be sure to check and preset as the following.

Remote Controller (RC)

The remote controller can cover all the functions of cooling models. Heating mode is not applicable for cooling models.

Auto-Restart Function

If you want to use auto-restart , switch on the power supply button, press the ON/OFF button on the Indoor, Unit ,hold for over 5seconds. Auto Restart is now set with buzz sound.

If the auto restart has been set, hold down the ON/OFF button on the indoor unit for over 5 Seconds, auto restart function is now cancelled with a buzz sound, air conditioner is now on standby.

Safety Precautions

Symbols in this Use and Care Manual are interpreted as shown below



Be sure not to do.















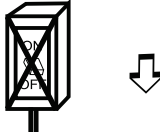





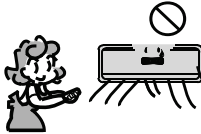

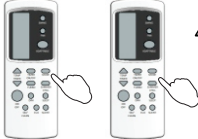

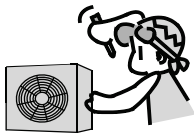
Grounding is essential.

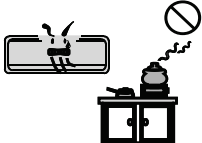

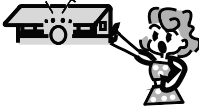
Pay attention to such a situation.

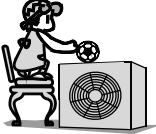

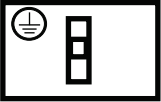
Warning: Incorrect handling could cause a serious hazard, such as death, serious injury, etc.

 <p>Use correct power supply in accordance with the rating plate requirement. Otherwise, serious faults or hazard may occur or a fire maybe break out.</p>	  <p>Keep the power supply circuit breaker or plug from dirt. Connect the power supply cord to it firmly and correctly, lest an electric shock or a fire break out due to insufficient contact.</p>	  <p>Do not use the power supply circuit breaker or pull off the plug to turn it off during operation. This may cause a fire due to spark, etc.</p>
  <p>Do not knit, pull or press the power supply cord, lest the power supply cord be broken. An electric shock or fire is probably caused by a broken power supply cord.</p>	  <p>Never insert a stick or similar obstacle to the unit. Since the fan rotates at high speed, this may cause an injury.</p>	  <p>It is harmful to your health if the cool air reaches you for a long time. It is advisable to let the air flow be deflected to all the room.</p>
  <p>Turn off the appliance by remote control firstly before cutting off power supply if malfunction occurs.</p>	  <p>Do not repair the appliance by yourself. If this is done incorrectly, it may cause an electric shock, etc.</p>	  <p>Prevent the air flow from reaching the gas burners and stove.</p>
  <p>Do not touch the operation buttons when your hands are wet.</p>	  <p>Do not put any objects on the outdoor unit.</p>	  <p>It is the user's responsibility to make the appliance be grounded according to local codes or ordinances by a licenced technician.</p>

Identification of Parts

Indoor unit

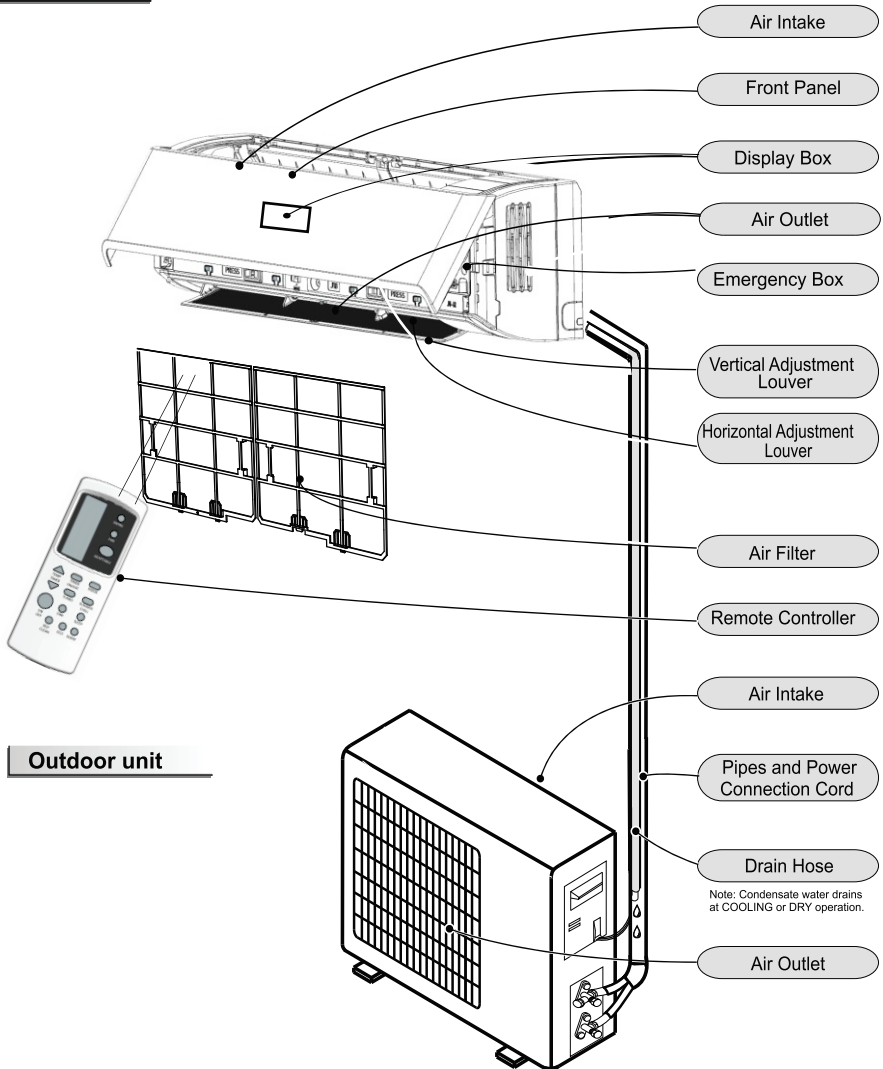

Outdoor unit

☑ The figures in this manual are based on the external view of a standard model. Consequently, the shape may differ from that of the air conditioner you have selected.

Display Introduction

Display Indicator

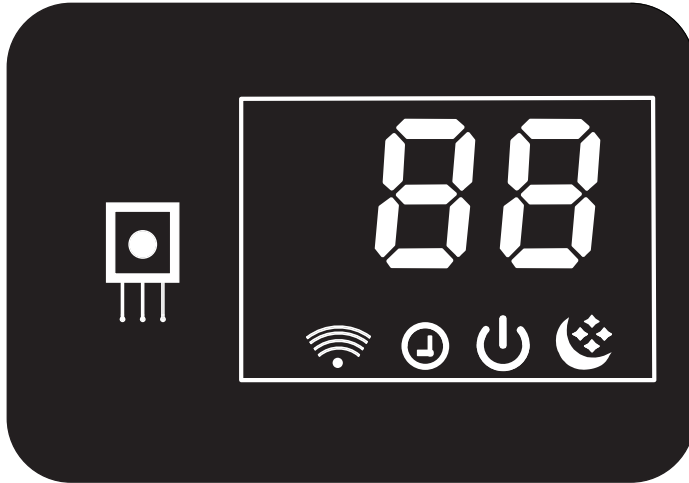

Display symbols:



Display Set Temperature



Cool Mode Indicator



ON/OFF Button



Timer Indicator



Wi-fi Indicator



Sleep Mode Indicator

Remote Controller

1 ON/OFF BUTTON

The appliance will be switched on or Off on pressing this button

2 TURBO BUTTON

This button is used to cool room quickly.

3 ADAPTABLE

Adaptable button to convert AC into different capacity (Only if feature is available).

4 FAN BUTTON

Used to select fan speed in sequence auto, low, medium or high

5 SWING BUTTON

Used to stop or start vertical adjustment lower swinging and set the desired up/down airflow direction. (only if the feature is available)

6 TEMP TIMER BUTTON

Used to adjust the room temperature and the timer

7 SELF CLEAN

Self clean button is use to set clean function

8 TIMER ON/OFF BUTTON

This button is used to set Timer operation

9 MODE BUTTON

Press this button to select the Operation mode

10 SUMMER CHILL BUTTON

Switch to Highest Compressor speed and Turbo Fan speed and Cools the room faster

11 DIM BUTTON

When you press this button, all the display of indoor unit will be switched off. Press DIM button to resume display

12 SLEEP BUTTON

Sleep button is used to set or cancel Sleep mode operation

13 SILENT BUTTON

This button is used to set the ultra silent operation.

14 ECO BUTTON

Used to enter or quit ENERGY SAVER mode

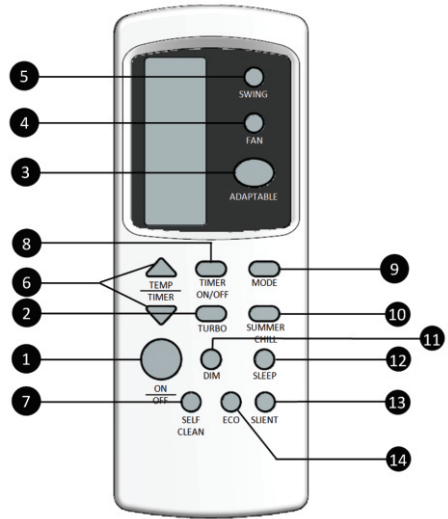





Operating Instructions

STANDBY ON/OFF

- This buttons is nominated by “ON/OFF” on remote control unit.
- It control of “Operation ON/OFF Switching” to the air conditioning.
- Only temperature 24°C displayed on remote LCD after inserted AAA batteries.

OPERATION MODES

This button is nominated by “MODE” on remote control unit. It changes the operation (operation switching) in cyclic way of air-conditioner (indoor unit) after each time of pressing this key.

Operation Mode	Corresponding Icons
AUTO MODE	
COOL	
DRY	
FAN	

SUMMER CHILL

- This feature is applicable only in cool mode.
- When summer chill feature is enable compressor bypass delay time, only when (Room temperature>Set temperature), and the IDU fan will runs at turbo speed.(Only if feature is applicable).
- If (Room temperature<Set temperature) then only IDU fan will runs at turbo speed. Summer chill feature is applicable only for 20 minutes.
- After 20 minutes the summer chill feature will be cancelled automatically.

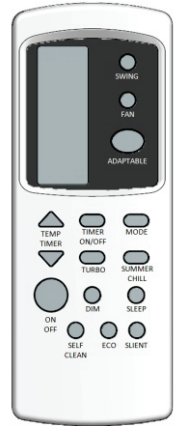

Operating Instructions

DRY MODE

- Set Temperature will be 24°C by default and it can't be varied by pressing temp up/down keys.
- Fan speed fixed to low speed and can't be varied.
- Turbo mode can't be set.
- Silent mode can't be set.
- Dim can be Enable/ Disable by pressing Dim key .
- Timer off can be Enable/ Disable by pressing Timer off key.
- Swing can be Enable/ Disable by pressing swing key

COOL MODE

Temperature can be varied from 16°C to 30°C by Pressing UP/DOWN keys.

- Fan speed can be varied by pressing fan speed key in the sequence of Low> Med> High>Auto On cyclic way.
- Sleep mode can be Enable/ Disable by pressing sleep key.
- Self-clean mode can be Enable / Disable by pressing Self Clean key.
- Turbo mode can be Enable/ Disable by pressing Turbo key.
- Silent mode can be Enable/ Disable by pressing Silent key.
- Eco mode can be Enable/ Disable by pressing Eco key.
- Dim can be Enable/ Disable by pressing Dim key.
- Adaptable can be Enable/Disable by pressing Adaptable

(If feature is available)

When Adaptable key is pressed, then icon shows c1, c2, c3 & c4

(If feature is available)

- Timer off can be Enable/ Disable by pressing Timer off key.
- Swing can be Enable/ Disable by pressing swing key.

FAN MODE

- Set Temperature will be 24°C by default and it can't be varied by pressing temp up/ down keys.
- Fan speed can be varied by pressing fan speed key in the sequence of Low > Med> High cyclic way and Auto fan speed can't be set.
- Sleep mode can't be set by pressing sleep key.
- Silent mode can't be set.
- Eco mode can't be set.
- Dim can be Enable/ Disable by pressing Dim key.
- Timer off can be Enable/ Disable by pressing Timer off key.
- Swing can be Enable/ Disable by pressing swing key
- Turbo mode can't be set.



Operating Instructions

SLEEP MODE

- Sleep will active when we press "sleep" key in cool mode from Handset.
- Sleep feature will active for 8 hours.
- Total 2 degree Preset temperature will increment in 2 hour (1 degree in 1 hour).
- After 2 hour unit will run for next 6 hours on same temperature.
- After completing 8 hours, sleep feature will be deactivated and preset temperature will return to previous settings.
- Increment value will not go to memory.

DIM FUNCTION

- Whenever dim function is enable, display will go off except function indicator.
- When dim is enable, if user presses any key, display will open for 5 second only.
- Dim function can be Enable / Disable by dim key.

TURBO MODE

- Turbo feature activates by pressing turbo key in cool mode only
- Fan Speed will be turbo
- Swing will set at default position.
- During turbo set temperature can be changed by the user.

SILENT OPERATION

- When Silent key is pressed by the user the IDU fan will run at minimum speed.
- Silent mode activates in cool mode only.

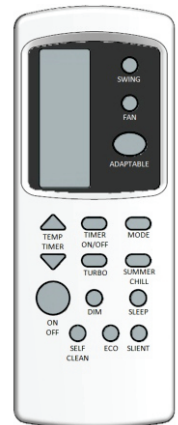
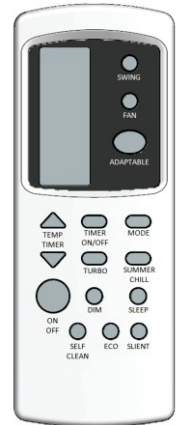

Operating Instructions

ECO FUNCTION

- It only operates in cool.
- When ECO is enable then fan speed is not changeable.
- When we set the temperature (between 16°C to 30°C) by pressing Eco key the default temperature would be 24°C .
- Press again Eco key for stop the energy saver function. On LCD of remote control unit, can't be recall the previous set temperature.
- Set Eco function can be cancelled by itself button, on/off,summer chill key and Mode key.

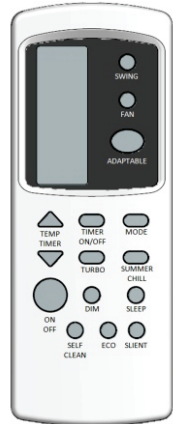

ADAPTABLE OPERATION (Only for Inverter Model)

- By Pressing the Adaptable key, AC comes to desirable tonnage requirement thus saving energy.
- It only works in Cool Mode.

FOR 1T INV MODELS	
ADAPTABLE	TONNAGE
C1	0.9 T
C2	0.8 T
C3	0.7 T
C4	1.2 T

FOR 1.5T INV MODELS	
ADAPTABLE	TONNAGE
C1	1.3 T
C2	1.1 T
C3	0.9 T
C4	1.7 T

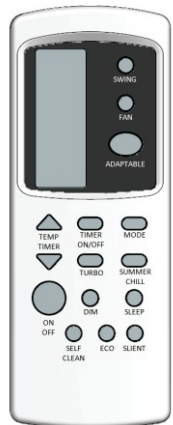

AIRFLOW DIRECTION CONTROL

- Vertical airflow is automatically adjusted to a certain angle in accordance with the operation mode after turning on the unit.

Operation mode	Direction of airflow
COOLING, DRY	horizontal
*HEATING, FAN ONLY	downward

The direction of airflow can be also adjusted to your own requirement by pressing the "SWING" button of the remote controller.

**Heating mode is only available for heat pump models.*

SELF CLEAN

- Press the self clean button for 5 seconds to enter clean mode.
- IDU display shows CL, louver swing to the minimum position.
- At the same time, ODU will run for 10 minutes.
- After 10 minutes Outdoor unit will switch Off and Indoor unit fan will start for 5 minutes
After 5 minutes the self clean feature will be cancelled and system will run at previous setting

GAS LEAKAGE (Only Applicable in Inverter Model)

- If Gas is leaked from Air conditioner, E5 will display on Indoor unit.
- E5 error can be checked manually after Air Conditioner run for 1hr.
- E5 Feature Performance -
 - 1 Pipe Length : Excess pipe length during installation will not have much impact on cooling however it might impact the efficiency of E5 Error.
 - 2 Voltage : Sudden change in input voltage might impact the efficiency of E5 Error.
 - 3 Heat Exchanger : As it is advised to check the blockage in Heat exchanger (evaporator & condenser) periodically. Heavy blockage might impact cooling as well as efficiency of E5 Error.

Operating Instructions

HORIZONTAL AIRFLOW CONTROL (WITH HANDS)

Turning the control rods of the horizontal adjustment louvers to change horizontal air flow as shown.

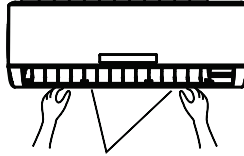

control rods of horizontal adjustment louvers

Note: The shape of the unit may look different from that of the air conditioner you have selected.

- A** Do not turn the vertical adjustment louvers manually, otherwise malfunction may occur. If that happens, turn off the unit first and cut off the power supply, then restore power supply again.
- B** It is better not to let the vertical adjustment louver tilt downward for a long time at COOLING or DRY mode to prevent condensed water from dripping.



► TIMER ON/OFF OPERATION

It is convenient to set the timer on with **TIMER ON/OFF** buttons when you go out in the morning to achieve a comfortable room temperature when you get home. You can also set the timer off at night to enjoy a good sleep.

- TIMER ON command will work when system is in standby condition.

► How to set the TIMER ON

The TIMER ON button can be used to set the timer to switch on the appliance at your desired time.

- i) Press the TIMER ON button and, you can then press the  or  buttons to select the time you wish for the appliance to turn on.



► How to cancel TIMER ON

Press the TIMER ON button two times. Once you hear a "beep" and the indicator disappears, the TIMER ON mode has been canceled.

Operating Instructions

OPERATION WITHOUT THE REMOTE CONTROL

If you have lost the remote control unit or if its malfunctioning, follow the steps below.

1. How to turn on the air conditioner:
Open the front panel(if necessary), press the ON/OFF button with a ball-point.Then the air conditioner will automatically select the operation mode according to the room temperature.
2. How to turn off the air conditioner:
Open the front panel(if necessary), press ON/OFF button with a ball-point.

Note: Do not press the ON/OFF button too long, as it may cause the air conditioner to operate abnormally.

TIPS FOR ENERGY SAVING

If the air inlet and air outlet is blocked it might affect the normal heat exchange of the air conditioner and even cause damage to the appliance. When the air conditioner is operating in Cooling Mode during the daytime, please use a sun shield or curtains to keep from direct sunlight from entering into the the room. IF the walls and ceiling are irradiated by sunlight, it will take a long time to achieve the set temperature during cooling operation. Clean the air-filters at a certain time(about every two weeks) and keep the air-filters clean to ensure normal heat exchange of the indoor unit. Keep the door and windows well closed when the air-conditioners is running to avoid loss of heat.

FUNCTIONS AVAILABLE IN DIFFERENT MODES

	COOL	DRY	FAN
SLEEP	√	X	X
DIM	√	√	√
SELF CLEAN	√	X	X
ECO	√	X	X
TURBO	√	X	X
FAN SPEED	√	X	√
SILENT	√	X	X
ADAPTABLE	√	X	X
TIMER	√	√	√
SWING	√	√	√

**BEE Test Setting by Remote

- Full Load :- Set cool mode at high fan speed at 16 degree and then continuously press DIM key for eight times.
- Half Load :- Set cool mode at high fan speed at 17 degree and then continuously press DIM key for eight times.

** Applicable to specific models

Safety Instructions

- Before using the appliance, read this safety instructions. Keep them nearby for future reference. These instructions and the appliance itself provide important safety warnings, to be observed at all times.
- The manufacturer declines any liability for failure to observe these safety instructions, for inappropriate use of the appliance or incorrect setting of controls.
- Do not let air enter the refrigeration system or discharge refrigerant when moving the air conditioner
- Very young children (0-3 years) should be kept away from the appliance . Young children (3-8 years) should be kept away from the appliance unless continuously supervised. Children from 8 years old and above and persons with reduced physical, sensory or mental capabilities or lack of experience and knowledge can use this appliance only if They are supervised or have been given instructions on safe use and understand the hazard involved. Children must not play with the appliance. Cleaning and user maintenance must not be carried out by children without supervision
- CAUTION : the appliance is not intended to be operated by means of an external switching devices, such as a timer , or separate remote controlled system.
- This appliance is intended to be used in household and similar applications such as: hotel and working office. The appliance shall not be installed in the laundry.
- This appliance is not for professional use
- Always turn off the air conditioner by remote control first. Do not use the power supply circuit breaker or pull off the plug to turn it off.
- Disconnect the air conditioner from the power supply if it is to be left unused for a long period of time or during a thunder/lightning storm.
- Never insert obstacle in the air outlet - risk of injury. Keep ventilation openings clear of any obstruction.
- Do not place any other electrical products or household belongings under indoor unit or outdoor unit. Condensation dripping from the unit might get them wet, and may cause damage or malfunction of your property.
- The appliance must be handled and installed by two or more persons - risk of injury. Use protective gloves to unpack and install - risk of cuts
- Installation, including electrical connections, and repairs must be carried out by a qualified technician according to national wiring rules. Do not repair or replace any part of the appliance unless specifically stated in the user manual.
- Keep children away from the installation site.
- After unpacking the appliance, make sure that it has not been damaged during transport.
- In the event of problems, Please contact 18001033333 Service Helpline.
- The appliance must be disconnected from all remote power supply before any installation operation - risk of electrical shock. During installation , make sure the appliance does not damage the power cable - risk of fire or electric shock.
- Only activate the appliance when the installation has been completed.
- Do not use the power supply circuit breaker or pull off the plug to turn it off.

Safety Instructions

- Warning: Risk of electric shock can cause injury or death: Disconnect all remote electric power supplies before servicing
- The maximum length of the connecting pipe between the indoor unit and outdoor unit should be less than 5 meters. It will affect the efficiency of the air conditioner if the distance longer than that length.
- Mount the indoor unit at least 2.5m above floor or grade level.
- The appliance shall be installed in accordance with national wiring regulations.
- The batteries in remote controller must be recycled or disposed of properly Disposal of Scrap Batteries. Please discard the batteries as sorted municipal waste at the accessible collection point.
- If the supply cord is damaged, it must be replaced by the manufacturer, its service agent or similarly qualified persons in order to avoid a hazard.
- The appliance shall not be installed in the laundry.
- Do not use extension leads, multiple sockets or adapters. The electrical components must not be accessible to the user after installation.
- Do not operate this appliance when you are wet or barefoot. Do not operate this appliance if it has a damaged power cable or plug, if it is not working properly, or if it has been damaged or dropped.
- The power supply must be of rated voltage with special circuitry for the appliance. The diameter of the power cord must comply with requirements
- An all-pole disconnection switch having a contact separation of at least 3mm in all poles should be connected in fixed wiring in accordance national with wiring rules, and the appliance must be earthed in conformity with national electrical safety standards.
- A residual current device (RCD) having rated residual operation current not exceeding 30mA shall be incorporated in fixed wiring according to national law.
- The temperature of refrigerant circuit will be high, please keep the interconnection cable away from the copper tube.
- Ensure safe grounding and a grounding wire connected with the special grounding system of the building, installed by professionals. The appliance must be fitted with electrical leakage protection switch and an auxiliary circuit breaker with sufficient capacity.
- The circuit breaker must also have a magnetic and a thermal tripping function to ensure protection in case of short-circuit and overload.

Model	Upto 12K	≤ 18 K	≤ 24 K
Required capacity of Circuit breaker	16A	20A	25A

- For the connection of power cord and cable connection between indoor and outdoor units, please see the wiring diagram on the appliance
- Never use steam cleaning equipment.
- This product contains Fluorinated Greenhouse Gases covered by the Kyoto Protocol, the refrigerant gas being in a hermetically sealed system. (R32, GWP 675) Please refer to the rating label for detail information.

Safety Instructions

This product contains Mildly flammable refrigerant R32, Shall strictly follow the safety instructions as below :

- Do not use means to accelerate the defrosting process or to clean, other than those recommended by the manufacturer
- The appliance shall be stored in a room without continuously operating ignition sources (for example open flames, an operating gas appliance or an operating electric heater).
- Do not pierce or burn. Be aware that refrigerants may not contain an odor
- Servicing shall only be performed as recommended by the equipment manufacturer. Maintenance and repair requiring the assistance of other skilled shall be carried out under the supervision of the person competent in the use of flammable refrigerants. In case of field charge, the effect on refrigerant charge caused by the different pipe length has to follow manufacturer's instruction.
- The installation of pipework shall be kept to a minimum. Mechanical connections shall be accessible for maintenance purposes.

Safety Precautions: WHAT IF

• **When executing a repair Indoors:**

Make sure that there is always forced (fan) ventilation (+ 500 m³/h) to guarantee the supply of fresh air and extraction of R32 out of the room to avoid concentration rise above the LFL.

• **When executing a repair Outdoors:**

Forced ventilation is only required when there is a possibility of refrigerant accumulation due to the surrounding walls, or when unit is installed in a pit.

• **Accidental release of R32:**

Ensure enough ventilation. Cut all power to the unit and try to extinguish any open flame when any accidental release of R32 should occur. Evacuate the room and wait to return to the unit until all refrigerant has evaporated and evacuated.

• **Replace spare parts specified by Manufacturer Only :**

Do not try to modify or to add any inductive/capacitance loads to the circuit. Replace components only with parts specified by the manufacturer.

Additional Precautions:

Precautions when performing electrical work or replacing electric components:

Keep a sufficient distance away from causes of fire (ignition sources) such as gas burning equipment and electric heaters in places where installation, repairs, or similar work on air-conditioning equipment is performed.

Check that there are no dangerous or combustible items nearby, and ensure a fire extinguisher is close at hand.

If the gas comes into contact with open flame or other material heated to > 300 to 400°C, it will cause thermal decomposition, possibly producing toxic gas.

Cautions during vacuuming and charging:

- Do not overfill the refrigeration system.
- Ensure that contamination of different refrigerants does not occur when using charging equipment.



Maintenance

1 Cut off the power supply

Turn off the appliance first before disconnecting from power supply.

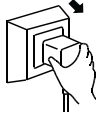

2

Grasp position "a" and pull outward to remove the front panel.



3 Wipe with a soft and dry cloth.

Use soft moisture cloth to clean if the front panel is very dirty.



4 Never use volatile substance such as gasoline or polishing powder to clean the appliance.



5 Never sprinkle water onto the indoor unit

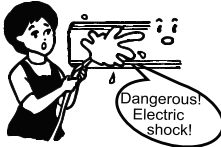

6 Reinstall and shut the front panel.

Reinstall and shut the front panel by pressing position "b" downward.



It is necessary to clean the air filter after using it for about 100 hours.

Clean it as follows:

1 Stop the appliance and remove the air filter .

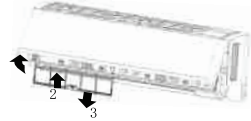

1. Open the front panel.
2. Press the handle of the filter gently from the front.
3. Grasp the handle and slide out the filter.

2 Clean and reinstall the air filter .

If the dirt is conspicuous, wash it with a solution of detergent in lukewarm water. After cleaning, dry well in shade.



3 Close the front panel again.

- Clean the air filter every two weeks if the air conditioner operates in an extremely dusty environment.

Protection

The protective device maybe trip and stop the appliance in the cases listed below

COOLING	Outdoor air temperature is over 48°C.
	Room temperature is below 20°C
DRY	Room temperature is below 16°C

If the air conditioner runs in **COOLING** or **DRY** mode with door or window opened for a long time when relative humidity is above 80%,dew may drip down from the outlet.







- Install the air conditioner at a place that can bear its weight in order to operate more quietly.
- Install the outdoor unit at a place where the air discharged and the operation noise would not annoy your neighbors.
- Do not place any obstacles in front of the air outlet of the outdoor unit lest it increases the noise level.

Features of protector

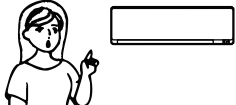
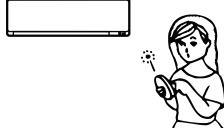
- 1 The protective device will work at following cases.
 - Restarting the unit at once after operation stops or changing mode during operation, you need to wait 3 minutes.
 - Connect to power supply and turn on the unit at once, it may start 20 seconds later.
- 2 • If all operation has stopped, press ON/OFFbutton again to restart, Timer should be set again if it has been canceled.

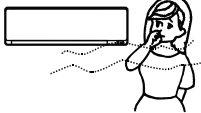
Troubleshooting

The following cases may not always be a malfunction, please check it before asking for service.

<p>Does not run</p> 	<ul style="list-style-type: none"> • If the protector trip or fuse is blown. • Please wait for 3 minutes and start again, protector device may be preventing unit to work. • If batteries in the remote controller exhausted. • If the plug is not properly plugged.
<p>No cooling or heating air</p> 	<ul style="list-style-type: none"> • Is the air filter dirty? • Are the intakes and outlets of the air conditioner blocked? • Is the temperature set properly?
<p>Ineffective control</p> 	<ul style="list-style-type: none"> • If strong interference (from excessive static electricity discharge, power supply voltage abnormality) presents, operation will be abnormal. At this time, disconnect from the power supply and connect back 2-3 seconds later.
<p>Does not operate immediately</p> 	<ul style="list-style-type: none"> • Changing mode during operation, 3 minutes will delay.
<p>Peculiar odor</p> 	<ul style="list-style-type: none"> • This odor may come from another source such as furniture, cigarette etc, which is sucked in the unit and blows out with the air.
<p>A sound of flowing water</p> 	<ul style="list-style-type: none"> • Caused by the flow of refrigerant in the air conditioner, not a trouble. • Defrosting sound in heating mode.
<p>Cracking sound is heard</p> 	<ul style="list-style-type: none"> • The sound may be generated by the expansion or contraction of the front panel due to change of temperature.
<p>Spray mist from the outlet</p> 	<ul style="list-style-type: none"> • Mist appears when the room air becomes very cold because of cool air discharged from indoor unit during COOLING or DRY operation mode.
<p>The compressor indicator lights on constantly, and indoor fan stops.</p>	<ul style="list-style-type: none"> • The unit is shifting from heating mode to defrost. The indicator will lights off within ten minutes and returns to heating mode.
<p>How to check E5 feature with Remote.</p>	<ul style="list-style-type: none"> • Press sleep button 6 times with Remote.

Troubleshooting Chart

Fault	Symptoms	Probable cause	Trouble Point	Remedy	
LESS COOLING	1 Supply Air is cold but room is not cooled.	1 Excessive Cooling load	1 Room is too large for chosen capacity.	1 Recalculate the cooling load.	
			2 Direct Sunlight enters the room being cooled.	2 Do not install air conditioner near heater and other sources.	
			3 Doors are opened and closed frequently or room contain too many persons		
			4 Heat sources such as heaters and cooking stoves, etc. are presents.		
		2 Unsuitable installation location	1 Check if room air conditioner is installed in corner.	1 Change installation location.	
			2 Check for any obstructing object in front of room air conditioner	2 Remove any obstructing object.	
	3 Insufficient air flow .	1 Dust accumulates in the air filter.	1 Wash out the dust on the air filter.		
		2 Dust adheres to fins w hich causes less air flow .	2 Clean the fins w ith brus and w ater.		
	2 Compressor is operating, but supply air is not cooled sufficiently	1 Defective refrigerating cycle.	1 Refrigerant leakage from the brazed section in piping.	1 Check each section w ith halogen gas leak detector and repair it immediately w hen a leaking section is detected.	
		2 ambient condition	1 compressor becomes overloaded and stops w ith the actuation of overload relay	1 check for direct sunlight on air conditioner	
	3 compressor stops soon after starting	1 variation of pow er source voltage and pow er source capacity	1 supply voltage is not in range of +- 10% of rated	1 use stabilizers for regulated pow er supply	
		2 ambient condition	2 compressor becomes overloaded and stops w ith the actuation of overload relay	2 check for any sunlight on air conditioner	
3 compressor running capacitor becomes poor or disconnected		3 check electrical w ire and compressor running capacitor w ith capacitor	3 replace the defective capacitor		
4 defective refrigerating cycle and overload		3 measure the voltage and current abnormally	4 repair refrigerating cycle and overload relay		
5 defective compressor		5 check compressor winding resistance and compare w ith specification	5 replace any defective compressor		
DOES NOT COOL AT ALL	1 Fan motor does not run	1 poor contact of plug, broken w ire, switches thermistor	1 measure the continuity of cord or voltage w ith a tester	1 replace any plug or part w ith poor contact or cord w ith broken arive	
		2 fan motor failure	2 check the broken connection in fan motor itself burnt and effect	2 check w ith DC motor testing jig if faulty replace the	
	2 fan motor is running but compressor does not operate	1 variation of pow er source voltage and pow er source capacitor	1 supply voltage is not in range of ~ 10% of rated	1 use stabilizers for regulated pow er supply	
		2 ambient condition	2 compressor becomes overloaded and stops w ith the actuation of overload relay	2 check for any direct sunlight on air conditioner	
		3 compressor running capacitor becomes poor or disconnected	3 check electrical w ire and compressor running capacitor w ith capacitor	3 replace the defective capacitor	
		4 defective refrigerant cycle or overload relay	4 measure the voltage and current abnormally	4 repair refrigerating cycle and overload relay	
		5 defective compressor	5 check compressor winding resistance and compare w ith specification	5 replace any defective compressor	
	3 compressor is operating but air is not cooled at all	1 gas leakage	1 measure the voltage and current abnormally	1 Check each section w ith halogen gas leak detector and repair it immediately w hen a leaking section is detected.	
		2 compressor w ith defective valve		2 replace any defective component	
	NOISE & VIBRATION	1 compressor noise	1 compressor w ith damaged piping suspension spring	1 observe for any normal noise	1 replace the compressor
		2 Knocking noise	2 blow er fan or pro fan hitting w ith foreign material	2 check for any object around fan	2 remove any foreign material from the system
3 Reasoning noise due to vibration		1 Installation is not proper and parts of air conditioner are loose or internal parts of the compressor are damaged	1 Check the degree of vibration and installation w ith accuracy	1 take proper measure to correct	
WATER DRIPPING	1 Water dripping inside room	1 Tilted unit installation	1 Check unit installation	1 if necessary reinstall the unit	
		2 Air filter may be dirty or clogged	2 Check air filter	2 clean dirty filter	

Installation Instructions

Installation diagram

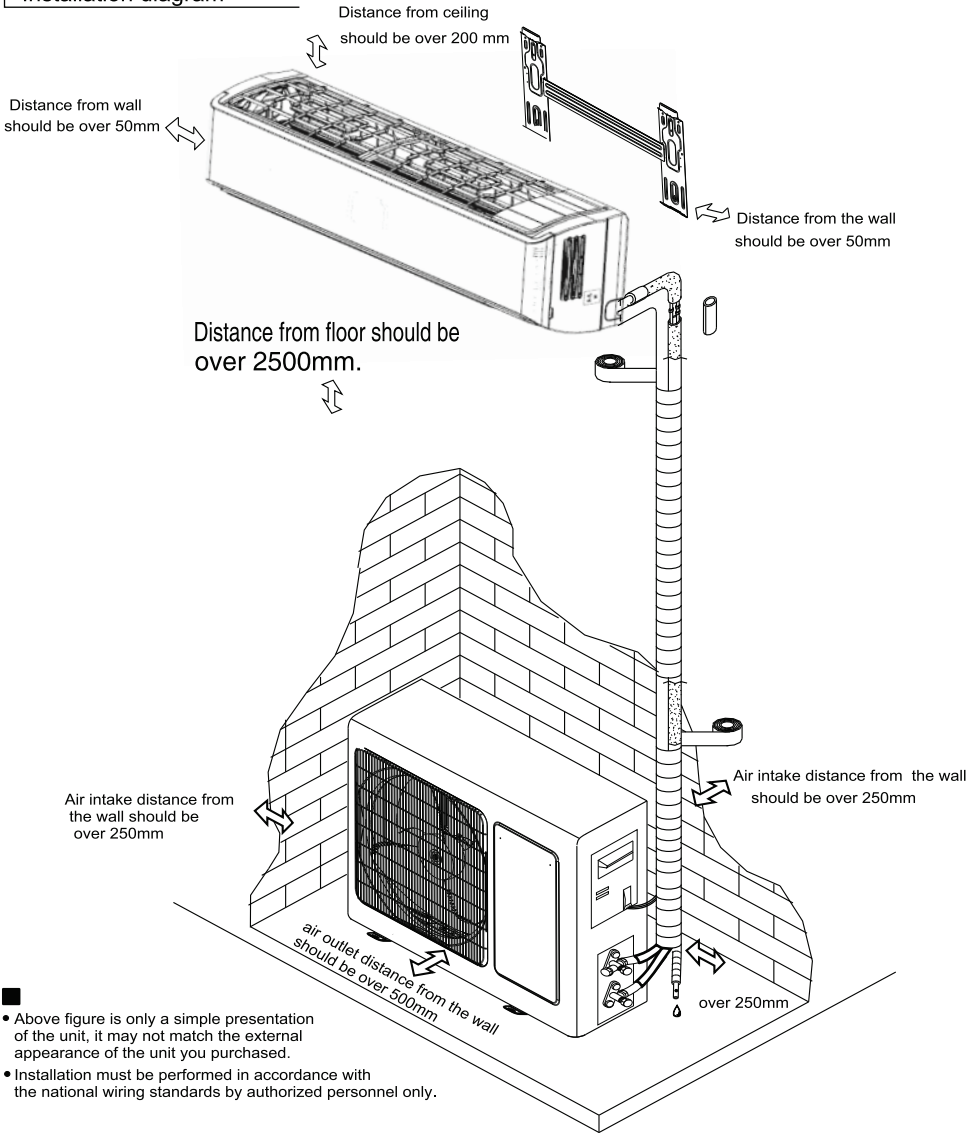

Installation Instructions

Select the installation location

Location for Installing Indoor Unit

- Where there is no obstacle near the air outlet and air can be easily blown to every corner.
- Where piping and wall hole can be easily arranged.
- Keep the required space from the unit to the ceiling and wall according to the installation diagram on previous page.
- Where the air filter can be easily removed.
- Keep the unit and remote controller 1m or more apart from television, radio etc.
- To prevent the effects of a fluorescent lamps, keep as far as possible.
- Do not put anything near the air inlet to obstruct it from air absorption.
- Where there is strong enough to bear the weight and is not tend to increase operation noise and vibration.
- Do not install above the entrance i.e. Door or in front of the door. installation area should have sufficient strength and durability.
- IDU should not install far away from desired cooling area.
- Do not place any electronic equipment below the IDU unit. Ex: LCD, Computer etc.

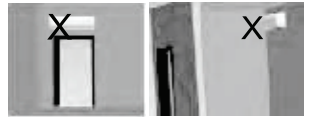
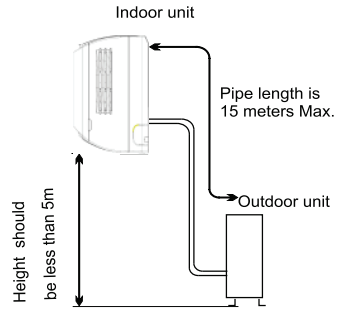

Location for Installing Outdoor Unit

- Where it is convenient to install and well ventilated. Do not install ODU face to face. Avoid the installation in South and West direction.
- Avoid installing it where flammable gas could leak.
- Keep the required distance apart from the wall.
- Installation Connecting pipe length provided with this model to be considered as a standard length to connect Indoor & Outdoor units.
- Keep the outdoor unit away from a place of greasy dirt, vulcanization gas exit.
- Avoid installing it at the roadside where there is a risk of muddy water.
- A fixed base where is not subject to increasing operation noise.
- Where there is not any blockage for air outlet. (Don't install in shaft) Installation area should have sufficient strength and durability. To get optimize efficiency, install under shed.

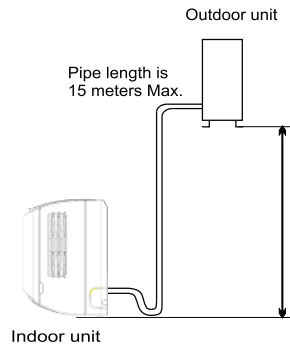

Model	Limit of Tubing Length (m)	Limit of Elevation Difference H (m)	*Required amount of additional refrigerant exceeding 10m pipe length (g/m)
5K~30K	15	5	20

*Be sure to add the proper amount of additional refrigerant. Failure to do so may result in reduced performance.

Installation Instructions

Below declared Connecting pipe length to be referred as standard length for Model Sold without Connecting Pipe.

Model	Pipe length
1.0T	3 Meter
1.5T	3 Meter
2.0T	3 Meter

Indoor unit installation

1. Installing the Mounting Plate

- Decide an installing location for the mounting plate according to the indoor unit location and piping direction.
- Keep the mounting plate horizontally with a horizontal ruler or dropping line.
- Drill holes of 32mm in depth on the wall for fixing the plate.
- Insert the plastic plugs to the hole, fix the mounting plate with tapping screws.
- Inspect if the mounting plate is well fixed. Then drill a hole for piping.

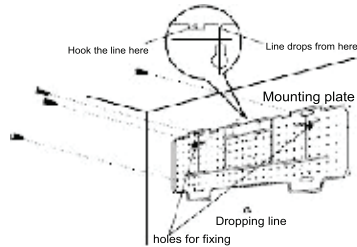

Note: The shape of your mounting plate may be different from the one above, but installation method is similar.

2. Drill a Hole for Piping

- Decide the position of hole for piping according to the location of mounting plate.
- Drill a hole on the wall with the help of drill machine. The hole should tilt a little downward toward outside.
- Install a sleeve through the wall hole to keep the wall tidy and clean.

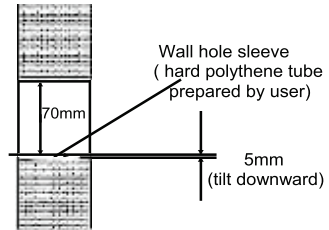

3. Indoor Unit Piping Installation

- Put the piping (liquid and gas pipe) and cables through the wall hole from outside or put them through from inside after indoor piping and cables connection complete so as to connect to outdoor unit.
- Check unloading piece off in accordance with the piping direction.(as shown below) and use tube bender the copper pipe.

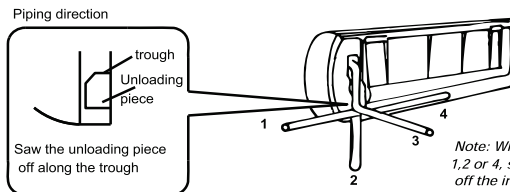

Note: When installing the pipe at the directions 1,2 or 4, saw the corresponding unloading piece off the indoor unit base.

- After connecting piping as required, install the drain hose. Then connect the power cords. After connecting, wrap the piping, cords and drain hose together with thermal insulation materials. IDU should be mounted perfectly on mounting plate, Lock should be properly inserted.

Installation Instructions

Recommendation Piping Joints Thermal Insulation:
Wrap the piping joints with thermal insulation materials and then wrap with a vinyl tape.

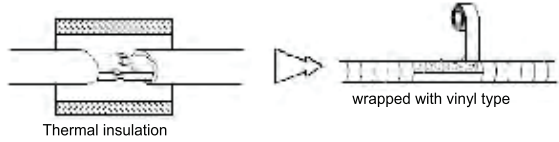

Piping Thermal Insulation:

- Place the drain hose under the piping.
- Insulation material uses polythene foam over 6mm in thickness.
Note: Drain hose is prepared by user.

Drain pipe should point downward for easy drain flow. Do not arrange the drain pipe twisted, sticking out or wave around, do not immerse the end of it in water.

If an extension drain hose is connected to the drain pipe, make sure to thermal insulated when passing along the indoor unit.

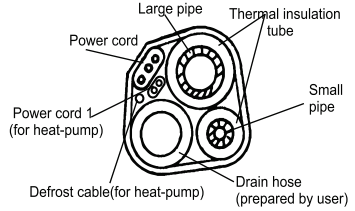

When the piping is directed to the right, piping, power Cord and drain pipe should be thermal insulated and fixed onto the back of the unit with a piping fixer.

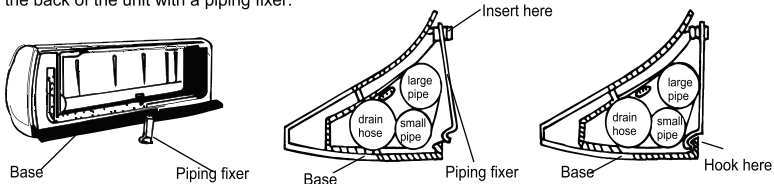

- Insert the pipe fixer to the slot.
- Press to hook the pipe fixer onto the base.

Piping Connection:

- Connect indoor unit pipes with two fix spanners. Pay special attention to the allowed torque as shown below to prevent the pipes, connectors and flare nuts from being deformed and damaged. Do not use adjustable wrenches.
- Pre-tighten them with fingers at first, then use the spanners.

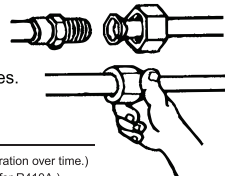

CAUTION

- Use the lare nut fixed to the main unit. (This is to prevent the lare nut from cracking as a result of deterioration over time.)
- To prevent gas leakage, apply refrigeration oil only to the inner surface of the flare. (Use refrigeration oil for R410A.)
- Use a torque wrench when tightening the lare nuts to prevent damage to the lare nuts and gas leakage.

- Align the centers of both lares and tighten the lare nuts 3 or 4 turns by hand, then tighten them fully with a spanner and a torque wrench.

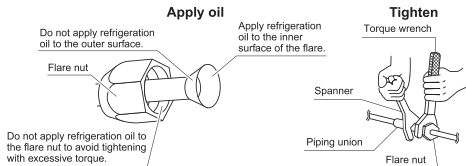

Model	Pipe size	Torque	Nut width	Min.thickness
1. 0 TR-2*,3*&5*	Liquid Side (1/4")	15-20N·m	17mm	0.6mm
1. 5 TR-2*,3*&5*	Liquid Side (1/4")	15-20N·m	17mm	0.6mm
2.0 TR-2*&3*	Liquid Side (1/4" & 3/8")	15-20 & 30-35N·m	17 & 22mm	0.6mm
1. 0 TR-2*,3*&5*	Gas Side (1/2")	50-55N·m	24mm	0.6mm
1. 5 TR-2*,3*&5*	Gas Side (1/2")	50-55N·m	24mm	0.6mm
2.0 TR-2*&3*	Gas Side (5/8")	60-65N·m	27mm	0.6mm

Do not cut or short pipe length provided with product during installation, roll & fix pipe with ODU.

Installation Instructions

4. Connecting of the Cable

● Indoor Unit

Connect the power connecting cord to the indoor unit by connecting the wires to the terminals on the control board individually in accordance with the outdoor unit connection.

Note: For some models, it is necessary to remove the cabinet to connect to indoor unit terminal.

● Outdoor Unit

- 1). Remove the access door from the unit by loosening the screw. Connect the wires to the terminals on the control board individually as the following.
- 2). Secure the power connecting cord onto the control board with cable clamp.
- 3). Reinstall the access door to the original position with the screw.
- 4) Use a recognized circuit breaker between The power source and the unit. A disconnection device to Adequately disconnect all supply line must be fitted.

Caution:

1. **Never fail to have an individual power circuit specifically for the air conditioner. As for the method of wiring, refer to the circuit diagram posted on the inside of the access door .**
 2. **Confirm that the cable thickness is as specified in the power source specification.**
 3. **Check the wires and make sure that they are all tightly fastened after cable connection.**
 4. **Be sure to install an earth leakage circuit breaker in wet or moist area.**
- 5. ODU Rubber pad to be used During Installation to Avoid Vibration & Noise.**

Cable Specifications

Capacity (Btu/h)	Power Cord		Power connecting cord		Main power supply(Note)
	Type	Normal cross-sectional area	Type	Normal cross-sectional area	
12k	IS:694	1.0mm ² X3	IS:694	1.0mm ² X3	To indoor
18k	IS:694	1.5mm ² X3	IS:694	1.5mm ² X3	To indoor
24k	IS:694	2.5mm ² X3	IS:694	2.5mm ² X3	To indoor

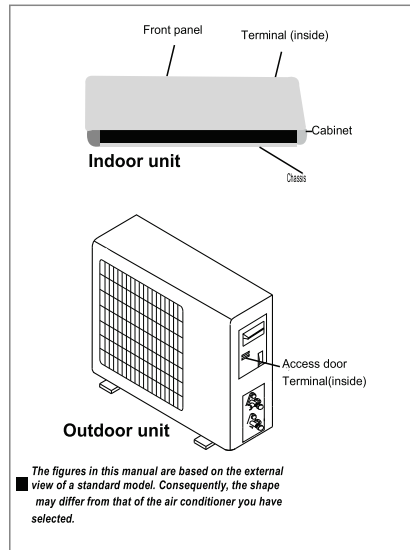

⚠ WARNING

- Do not use tapped wires, extension cords, or starburst connections, as they may cause overheating, electric shock, or fire.
- Do not use locally purchased electrical parts inside the product. (Do not branch the power for the drain pump, etc., from the terminal block.) Doing so may cause electric shock or fire.
- Do not connect the power wire to the indoor unit. Doing so may cause electric shock or fire.

Installation Instructions

Wiring Diagram

Make sure that the color of wires of the outdoor unit and the terminal No. are the same as those of the indoor unit.

- 12K,18K,24K Model

For above models, the power supply are connected from indoor unit.

Wiring Diagram

INVERTER PCB WIRING DIAGRAM

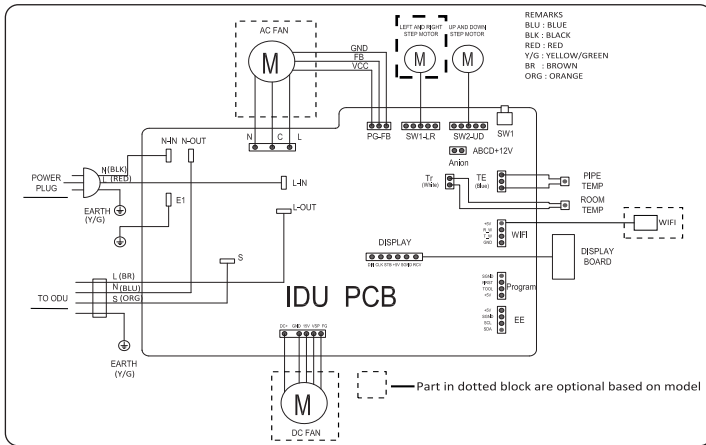

FIXED SPEED PCB WIRING DIAGRAM

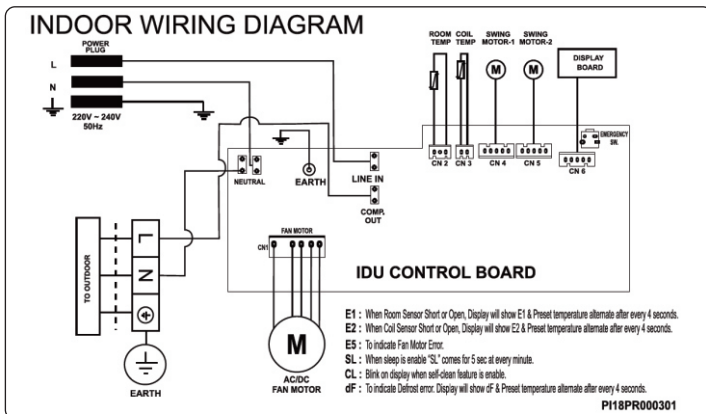

Installation Instructions

Outdoor unit installation

1. Install Drain Port and Drain Hose (for heat-pump model only)

The condensate drains from the outdoor unit when the unit operates in heating mode. In order not to disturb your neighbor and protect the environment, install a drain port and a drain hose to direct the condensate water. Just install the drain port and rubber washer to the chassis of the outdoor unit, then connect a drain hose to the port as the right figure shown.

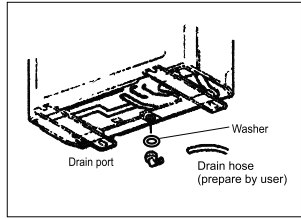

2. Install and Fix Outdoor Unit

Use rubber pad to fix with bolts and nuts tightly on a flat and strong floor. If installed on the wall or roof, make sure to fix the mounting stand and rubber pad well to prevent it from shaking due to serious vibration or strong wind.



3. Outdoor Unit Piping Connection

- Remove the valve caps from the 2-way and 3-way valve.
- Connect the pipes to the 2-way and 3-way valves separately according to the required torque.

4. Outdoor Unit Cable Connection (see previous page)

Leak Test/Evacuation/Gas Charging

The air which contains moisture remaining in the refrigeration cycle may cause a malfunction on the compressor. After connecting the indoor and outdoor units, evacuate air and moisture from refrigerant cycle using a vacuum pump, as shown below.

Note: To protect the environment, be sure not to discharge the refrigerant to the air directly. See next page for air purging steps.

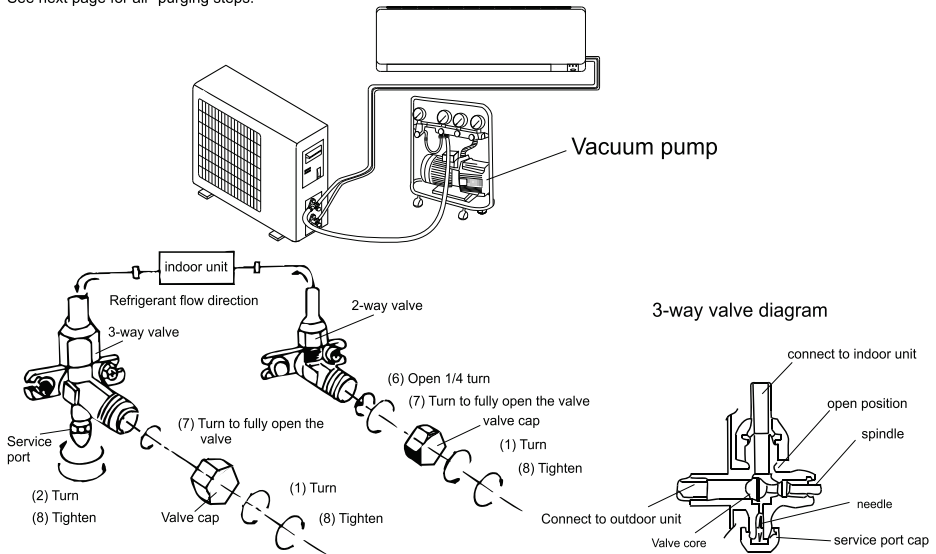

Installation Instructions

How to Purge Air Tubes:

1. Connect IDU & ODU connecting piping.
2. Connect the Manifold Gauge & Vacuum Pump to the charging valve.
3. Do the system evacuate atleast for 30 minutes with two stage vacuum pump when reaching a vacuum of 10mm Hg absolutes, switch off the pump & hold the vacuum for 5 minutes and check if the vacuum is breaking or not.
4. If vacuum breaks, then there is a leakage in system.
5. Rectify the leakage and do the vacuum again(Follow repeat of process)
6. If no vacuum breakage, open the spindles of 2-way & 3-way valves.
Then again check leakage with soap suds

Notes

- To guarantee the unit working normally, please read the manual carefully before installation, and try to install strictly according to this manual.
 - Do not let air enter the refrigeration system or discharge refrigerant when moving the air conditioner.
 - Earth the air conditioner properly.
 - Check the connecting cables and pipes carefully, make sure they are correct and firm before connecting the power of the air conditioner.
 - There must be an air-break switch.
 - After installing, the consumer must operate the air conditioner correctly according to this manual, keep a suitable storage for maintenance and move of the air conditioner in the future.
 - Type of fuse used on indoor unit controller is $\Phi 5 \times 20$, with rating 2.5A/250V or 3.15A/250V. .
 - Caution: Mount with the lowest moving parts of indoor unit at Least 2.4m above floor or grade Level.
 - Warning: Risk of electric shock can cause injury or death: Disconnect all Remote electric power supplies before servicing .
 - The maximum length of the connecting pipe between the indoor unit and outdoor unit should be less than 5 meters. It will affect the efficiency of the air conditioner if the distance longer than that length.
- • ***If the supply cord is damaged, it must be replaced by the manufacturer, its service agent or similarly qualified persons in order to avoid a hazard.***
- • ***The appliance shall be installed in accordance with national wiring .***

E-WASTE MANAGEMENT GUIDELINES



E-WASTE MANAGEMENT GUIDELINES (PERTAINING TO THE E-WASTE RULES)

PROPER HANDLING AND/OR RECYCLING OF THE AIR CONDITIONER

Under the E-Waste (Management & Handling) Rules, 2011 (hereafter referred to as the "E-Waste Rules"), it is incumbent for all consumers, including the purchaser of this air-conditioner, to properly recycle and dispose of all electrical and electronic equipment through authorized recyclers.

E-Waste has been defined as "waste electrical and electronic equipment, whole or in part or rejects from their manufacturing and repair process, which are intended to be discarded".

E-Waste contains various hazardous materials like lead, mercury, cadmium, hexavalent chromium, polybrominated biphenyls and polybrominateddiphenyls ethers. Hence, improper handling and disposal of e-waste releases these hazardous material in the environment causing pollution, contamination of soil and water and various health hazards. Though the product purchased by you is ROHS compliant and does not contain any hazardous material above the prescribed limit under the E-Waste Rules, it is imperative that the product should be handled with utmost caution and as per the guidelines mentioned in this manual including the following Do's and Don'ts –

Do's	Don'ts
Hand over the E-Waste to Authorised Recycler.	Never sell the e-waste to any unauthorized agencies, scrap dealer/kabadiwalahs.
E-Waste should be segregated from household and other wastes.	Never throw E-Waste in bins as part of household waste.
Keep the product in isolated area, after it becomes non-functional/un-repairable so as to prevent its accidental breakage.	Never keep E-Waste in open and exposed area, accessible by all.
The product should be opened only by authorised service personnel.	The product should not be opened by the user himself/ herself. Dismantling of e-waste by the user can be dangerous

The following marking/symbol on the product or carton indicates that the product and its accessories/parts (e.g. remote controller, batteries, spare parts etc.) should not be disposed of with other household waste at the end of their working life. Please separate these items from other types of waste and recycle them responsibly for conservation of the environment and collective well-being.



E-WASTE RECYCLING PROGRAM

We have tied up with government approved e-waste recycler for facilitating the collection of e-waste from our channel partners and customers for recycling. You are simply required to call our toll free number 18001033333 and register your request for collection of e-waste. Once your request is received, the representatives of the authorized recycler would collect the e-waste from your house/premises after paying the value of the same to you. For more details and information on our E-Waste Recycling Program kindly visit our website www.carriermidea.com.

ANNUAL MAINTENANCE CONTRACT

ANNUAL MAINTENANCE CONTRACT

Our air conditioners contain various components and inputs that are technical in nature and it is important that any repair or replacement of any of the components of the air conditioners is done only by the personnel authorized by Carrier.

We at Carrier Midea India Pvt. Ltd. believe in providing our valued customers the best in engineered technology & quality performance for extreme Indian conditions. Striving to keep our commitments and to ensure best product performance, We offer to you exciting “ Happy Homes Annual Maintenance plans” to cover the service support for your products.

We recommend that you avail Happy Homes annual maintenance services from us in order to optimize the performance and the life span of your conditioners and also to ensure their safe and proper handling.

You can contact to us on our call center number 18001033333 to register your request for Annual Maintenance services or you can write to us on carriercare@carriermidea.com

CARRIER MIDEA INDIA PRIVATE LIMITED (hereinafter referred to as the "Company"), hereby warrants to the original domestic purchaser (here in after called the "Purchaser") of the air-conditioning unit (as detailed within the Warranty Registration Card and here in after referred to as the "said unit") that the said unit is free from defects in materials and workmanship under normal use and service and under specified voltage conditions, and that during a period of twelve (12) months commencing from the date of invoice, as provided in the Warranty Card, the Company undertakes to repair or to replace any part or parts of the said unit (including the compressor, condenser and evaporator) free of charge which proves to be defective in materials or workmanship at its sole discretion.

ADDITIONAL WARRANTY ON COMPRESSOR

The additional warranty on Compressor will be continuous even after the expiry off one year period from date of purchase (4 year* for Normal Compressor & 9 year** for Inverter Compressor (selected Models) shall be applicable after the expiry of one year period from the date of purchase). This additional warranty covers compressor only. During the additional warranty period, it does not cover any parts such as condenser coil, evaporator coil, capillary, suction line electronics parts, etc., the Company shall continue to warranty the compressor to be free from defects in material and workmanship under normal use and service and under specified voltage conditions. The Company shall repair or replace without cost to the original purchaser, any part or portion of the compressor, which shall be returned to us, transportation charges prepaid and which on inspection shall be shown to be thus defective. Expendable items like refrigerant gas, overload, oil, dryer, strainer and others are excluded from this warranty and are on chargeable basis. This warranty is subject to use of air-conditioner with input voltage of 230 V +/-10%. We recommend use of approved make of voltage stabilizer with output voltage of 230 V +/-10%. The terms and conditions as set out below shall form the basis of this warranty:

***For Normal Compressor (4 Year Warranty)**

**** For Inverter Compressor (9 Year Warranty)**

1. The warranty shall be valid and that the Purchaser can have the benefit of this warranty, if and only if the Purchaser has duly intimated the fault to the Company or its authorized dealer if the and that the unit is in the possession of and is used by the Purchaser.
2. At the time of repair/service, the Purchaser is mandatorily required to show the original invoice to the authorized service personnel of the Company. If the purchaser fails to do so, then all repair work and service shall be carried out on a chargeable basis;
3. This warranty shall be valid only for the Warranty period irrespective of whether the said Unit has been in use or not for any reason whatsoever.
4. The Warranty will shall be valid only for the said period of twelve months as specified above, irrespective of whether the said unit has been in use or not for any reason whatsoever, or the unit is moved from one location to another. The warranty period specified above shall include time taken for repairs, replacements, testing of unit, technical breakdowns, transit time etc. This warranty shall automatically expire by efflux of time on completion of the period indicated herein above and no notice of such expiry will be given by the Company.
5. This warranty shall stand automatically terminated in the event of the said unit being serviced, repaired, installed, de-installed, re-installed or otherwise attended to by and person or organization or agency or by the said purchaser himself (by whatever name called), other that the authorized representative / Dealer of the the Company.
6. Parts of the units replaced or repaired under the terms of this warranty are warranted only for the remaining period of the original warranty period.

7. For attending any service call under this warranty beyond the Municipal limits of the locality in which the authorized representative/dealer is situated (outstation locations), all to and fro traveling and other incidental expenses as prevailing from time to time incurred in connection with the visit of the service personnel, technicians etc., shall be borne by the Purchaser and shall be payable in advance.
Additionally, all expenses incurred by the authorized representative/dealer in collecting the unit or any part thereof from such outstation locations and its return to the original location shall be borne exclusively by the Purchaser.
8. Any loss of refrigerant caused due to sabotage, improper handling or treatment, carelessness, accident, fire, flood, earthquake or any act of God, or any corrosive action on the original refrigerant pipes, fittings, valves etc. for whatever reason, shall not be covered under this warranty.
9. In the event of any change in the location of the unit, during the warranty period, this warranty shall become null and void unless the fact of the proposed change is communicated in writing to the authorized dealer at least seven (7) days prior to the said change. On receipt of such information, the authorized dealer or any of its counterparts shall arrange for de-installation of the said unit on a chargeable basis. However, it is expressly stated that in the event of any damage occurring to the unit or to any of its parts during the course of its transit by the Purchaser, repair or replacement of the said unit or any part thereof so damaged shall not be covered by this warranty.
10. While the Authorized Dealers/Company will make every effort to carry out repairs/replacement of parts under this warranty as soon as the complaint is received, it is expressly made clear that the Authorized Dealer/Company shall not be liable to do so within any specified period of time.
11. It shall be absolute discretion of the Company to (a) effect the repairs or replacement of parts whether at the site of installation or at any service center; and (b) have the job attended to either by the Company's service personnel or of its authorized dealers.
12. This warranty is in the nature of and for the purposes as set forth herein above and in particular, the Company shall not in any event be liable for any direct, indirect, incidental or consequential loss or damages to either the said purchaser and/or his property or any other third party in course of attending to any complaint.
13. Limitation of Warranty: Company shall not be responsible for providing any warranty under the following situations:
 - i. any damage caused by accident, mishandling, tampering with installation, or negligent in following instructions of the user manual issued by the Company,
 - ii. any damage caused by power surges and dips, improper electrical circuit outside the unit or by any defective electrical supply.
 - iii. at any time, during the currency of the warranty period, if any part of the unit is tampered with, altered, repaired or serviced by any unauthorized person, not being the authorized representative of the Company or its authorized dealers.
 - iv. If the said unit or any parts thereof is damaged by insects, rats, birds, squirrels, pests or any other external factors like fire, flood, earthquake, lightning and/or any other act of God/natural calamities;

WARRANTY TERMS AND CONDITIONS

- v. Any defect due to substitution of original components with non-genuine components;
 - vi. Damage to the said Unit due to use of any ancillary equipment which is not authenticated or recommended by the Company;
 - vii. The serial number on the unit or any part thereof is damaged, defaced, altered, obliterated, or tampered with or removed for any reason whatsoever.
 - viii. The unit is unauthorizedly removed from its original place or installation or reinstallation.
 - ix. Condenser and Evaporator is found defective if the air conditioner is installed near the muddy sewages because toxic gases are harmful for the AC.
 - x. Damage to the product due to operation in an abnormally corrosive alkaline / acidic atmosphere.
14. None of the employees and/or Authorized dealers of the Company have the authority whatsoever to vary the terms and conditions of this warranty.
15. This warranty shall be deemed to have been issued at Gurgaon in the State of Haryana, and Courts at Gurgaon shall have exclusive jurisdiction on matters covered by or following from this warranty, and the purchaser alone shall have cause of action arising out of the transaction.

WARRANTY CARD

WARRANTY

Carrier Midea India Private Limited

Customer Copy

Model :

NAME OF CUSTOMER :

ADDRESS :

Sr. No. of the Unit :

Sr. No. of the Compressor :

Invoice No. :

Date of Purchase :

Name & Address of the Dealer :



Signature of the Dealer with seal :

----->✂-----

WARRANTY

Carrier Midea India Private Limited

Carrier Copy

Model :

NAME OF CUSTOMER :

ADDRESS :

Sr. No. of the Unit :

Sr. No. of the Compressor :

Invoice No. :

Date of Purchase :

Name & Address of the Dealer :



Signature of the Dealer with seal :

WARRANTY CARD

PRODUCT WARRANTY CERTIFICATE

CARRIER MIDEA INDIA PRIVATE LIMITED (company) warrants this Room air conditioner to the original purchaser to be free from defects in material and workmanship under normal use and service and under specified voltage conditions and we shall, within one year from the date hereof, repair or replace any defect without cost to the original purchaser, a part or portion thereof which shall be returned to us, transportation charges prepaid, and which on inspection by the Company shall be shown to be thus defective. Plastic parts beyond the date of delivery, fuses, air filters, refrigerants, all and other expandable items are excluded from this warranty.

ADDITIONAL COMPRESSOR WARRANTY

For Additional warranty on Compressor (4 year for Normal Compressor & 9 year for Inverter Compressor), following the expiration of the entire unit warranty, the Company shall continue to warrant the compressor only to be free from defects in material and workmanship under normal use and service and under specified voltage conditions. The Company shall repair or replace without cost to the original purchaser compressor, any part or portion of the compressor, which shall be returned to the Company, transportation charges prepaid and which on inspection shall be shown to be thus defective. Expendable items like refrigerant gas (which is required to be filled in again mandatorily at the time of repairing or replacing the compressor), overload, oil, dryer, strainer and others are excluded from this warranty and are on chargeable basis.

These warranties, however, shall not apply if the room air-conditioner has been installed in a manner affecting the efficiency or performance, or if the room air-conditioner has been tampered with, altered or in any way, repaired, serviced or worked on by anybody other than the Company's own technicians/staff or its authorized representative. This warranty shall also NOT apply to the compressor which has the serial numbers altered, defected or removed. The company shall not be liable for any injury, loss, or damage (direct, indirect, or consequential) of whatsoever arising out of the use or inability to use the product.



PRODUCT WARRANTY CERTIFICATE

CARRIER MIDEA INDIA PRIVATE LIMITED (company) warrants this Room air conditioner to the original purchaser to be free from defects in material and workmanship under normal use and service and under specified voltage conditions and we shall, within one year from the date hereof, repair or replace any defect without cost to the original purchaser, a part or portion thereof which shall be returned to us, transportation charges prepaid, and which on inspection by the Company shall be shown to be thus defective. Plastic parts beyond the date of delivery, fuses, air filters, refrigerants, all and other expandable items are excluded from this warranty.

ADDITIONAL COMPRESSOR WARRANTY

For Additional warranty on Compressor (4 year for Normal Compressor & 9 year for Inverter Compressor), following the expiration of the entire unit warranty, the Company shall continue to warrant the compressor only to be free from defects in material and workmanship under normal use and service and under specified voltage conditions. The Company shall repair or replace without cost to the original purchaser compressor, any part or portion of the compressor, which shall be returned to the Company, transportation charges prepaid and which on inspection shall be shown to be thus defective. Expendable items like refrigerant gas (which is required to be filled in again mandatorily at the time of repairing or replacing the compressor), overload, oil, dryer, strainer and others are excluded from this warranty and are on chargeable basis.

These warranties, however, shall not apply if the room air-conditioner has been installed in a manner affecting the efficiency or performance, or if the room air-conditioner has been tampered with, altered or in any way, repaired, serviced or worked on by anybody other than the Company's own technicians/staff or its authorized representative. This warranty shall also NOT apply to the compressor which has the serial numbers altered, defected or removed. The company shall not be liable for any injury, loss, or damage (direct, indirect, or consequential) of whatsoever arising out of the use or inability to use the product.





For more details please contact Carrier Midea India Pvt. Ltd.:

REGISTERED OFFICE : 1st Floor, Pearl Global Tower, Plot No. 51, Institutional Area, Sector 32, Gurgaon - 122001, Haryana.

SALES OFFICES: Gurgaon: 0124-6144300, Ghaziabad: 0120-4183260, Chandigarh: 0172-5007548-50, Jaipur: 0141-4109080
Mumbai: 022-26528989, 42188800, Pune: 020-41051000, Goa: 0832-2447028, Ahmedabad: 079-40267777, Kolkata: 033-40201300, Chennai:
044-42222888, Bangalore: 080-43442000, Patna: 0512-2323517, Hyderabad: 040-45462888, Cochin: 0484-4029001, Lucknow: 0522-4158710,
Indore: 0731-4294700, Pondicherry: 0413-2226676, Coimbatore: 0422-4385400, Guwahati: 0361-2666077, Bhubaneswar: 0674-2585893,
Nagpur: 0712-6453790, Ranchi: 0651-6452488, 2330095, Raipur: 0771-4013245.

Visit us at : www.carriermideaindia.com

The design and specifications are subject to change without prior notice for product improvement. Consult with the sales agency or manufacturer for details.

PI18PR013700